



ELITE EM X ELLIPTICAL TRAINER

Owner's Manual



Questions? Call 888-888-7985

3G Cardio • 14647 So. 50th St. Suite 110 • Phoenix, AZ 85044

IMPORTANT! PLEASE READ:

If you purchased your 3G Cardio product from an online retailer (3GCardio.com, Amazon, etc..) and need help or have questions, comments or concerns, please call or email us (3G Cardio) directly. We are not operators, we are experienced fitness professionals and can help you with anything and everything!

If you purchased your 3G Cardio product from a “brick and mortar” retail store, feel free to contact the store directly with any questions or concerns. You are still more than welcome to contact us too!



3G Cardio Fitness Equipment
14647 So. 50th Street Suite 110
Phoenix, AZ 85044

1-888-888-7985
www.3GCardio.com
support@3gcardio.com

© Copyright 3G Cardio LLC
All Rights Reserved

Welcome to the 3G Cardio Family!

We are a highly experienced team of health and fitness equipment experts with over fifty years experience in the health and fitness industry. Our two main goals are to offer outstanding exercise equipment and to provide the best customer service experience possible.

We understand that you have many choices when it comes to fitness equipment. We know that our continued success is based upon the quality of the products we deliver and the client support we provide.

We will never cut corners to save money and we will always exceed your expectations!

If you ever have questions, problems or concerns, please contact us right away. We are fantastic at what we do and we would love a chance to prove it to you.

3G Cardio Family

1-888-888-7985

Support@3GCardio.com

Questions? Call 888-888-7985

3G Cardio • 14647 So. 50th St. Suite 110 • Phoenix, AZ 85044

Table of Contents

Safety Warnings and Precautions	1
Warm Up / Cool Down	2
Assembly Parts	3
Hardware Identification Chart	4
Before You Begin	5
Elite EM X Elliptical Trainer Assembly	6 - 15
Moving Your Elite EM X Elliptical Trainer	16
Console Instructions	17 - 27
Heart Rate Information	28
Bluetooth® Connectivity	29
Maintenance	30
Exploded Diagram	31 - 32
Parts List	33 - 34
Warranty	35

SAFETY WARNING

WARNING: To reduce the risk of serious injury, read the following safety instructions before using this machine.

- Read all warnings posted on the equipment
- Read this Owner's Manual and follow it carefully before using the equipment. Make sure that it is properly assembled and tightened before use
- We recommend that two people be available for assembly of this product
- Keep children and pets away from the equipment. Do not allow children and pets to use or play on the equipment. Always keep children and pets away from the equipment when it is in use
- It is recommended that you place this exercise equipment on an equipment mat
- Set up and operate the equipment on a solid level surface. Do not position the equipment on loose rugs or uneven surfaces. Do not lean against this machine as it presents a tipping hazard!
- Inspect the equipment for worn or loose components prior to each use
- Tighten / replace any loose or worn components prior to using the equipment
- Consult a physician prior to commencing an exercise program. If, at any time during exercise, you feel faint, dizzy, or experience pain, stop and consult your physician
- Follow your physician's recommendations in developing your own personal fitness program
- Always choose the workout which best fits your physical strength and flexibility level. Know your limits and train within them. Always use common sense when exercising
- Before using this product, please consult your personal physician for a complete physical examination.
- Do not wear loose or dangling clothing while using the equipment
- Never exercise in bare feet or socks; always wear correct footwear, such as running, walking, or cross-training shoes
- Be careful to maintain your balance while using, mounting, dismounting, or assembling the equipment loss of balance may result in a fall and serious bodily injury
- Keep both feet firmly and securely on the Foot Pedals while exercising
- The equipment should not be used by persons weighing over 350 pounds / 158 kgs
- The equipment should be used by only one person at a time
- The equipment is for semi-commercial, light-commercial and home usage
- Maintenance: Replace the defective components immediately and/or keep the equipment out of use until repair the equipment completely. Maintain the item regularly to make sure that any safety related features are working properly, replace any components that are dangerous and wearing (such as pedal, connection areas...etc.) right away.
- Make sure that adequate space is available for access to and passage around the equipment; keep at least a distance of 1 meter from any obstruction object while using the machine

WARNING: Before starting any exercise or conditioning program you should consult with your personal physician to see if you require a complete physical exam. This is especially important if you are over the age of 35, have never exercised before, are pregnant, or suffer from any illness.

!! IMPORTANT VOLTAGE INFORMATION !! Before plugging the power cord into an electrical outlet, verify that the voltage requirements for your area match the voltage of the machine that you have received. The power requirements for this machine are: 9V / 1.5 amps. This machine can be plugged into a standard 120v household outlet. The plug must be plugged into an appropriate outlet that is properly installed and grounded in accordance with all local codes and ordinances. **DANGER!** Improper connection of the equipment-grounding conductor can result in a risk of electric shock. Check with a qualified electrician or service provider if you are in doubt as to whether the machine is properly grounded.

WARM UP & COOL DOWN

A successful exercise program consists of a warm up, aerobic exercise, and a cool down. Warming up is an important part of your workout, and should begin every session. It prepares your body for more strenuous exercise by heating up and stretching out your muscles. At the end of your workout, repeat these exercises to properly cool down. We suggest the following warm up and cool down exercises:

1

Head Rolls

Rotate your head to the right for one count, feeling the stretch up the left side of your neck. Next rotate your head back for one count, stretching your chin to the ceiling and letting your mouth open. Rotate your head to the left for one count, and finally, drop your head to your chest for one count.



2

Shoulder Lifts

Lift your right shoulder up toward your ear for one count. Then lift your left shoulder up for one count as you lower your right shoulder.



3

Side Stretches

Open your arms to the side and continue lifting them until they are over your head. Reach your right arm as far upward toward the ceiling as you can for one count. Feel the stretch up your right side. Repeat this action with your left arm.



4

Inner Thigh Stretch

Sit with the soles of your feet together with your knees pointing outward. Pull your feet as close into your groin as possible. Gently push your knees toward the floor. Hold for 15 counts.



5

Toe Touches

Slowly bend forward from your waist, letting your back and shoulder relax as you stretch toward your toes. Reach down as far as you can and hold for 15 seconds.



6

Quadriceps Stretch

With one hand against a wall for balance, reach behind you and pull your right foot up. Bring your heel as close to your buttocks as possible. Hold for 15 counts and repeat with left foot up.



7

Hamstring Stretches

Sit with your right leg straight in front of you. Straighten your leg out while trying to hold on to your outstretched leg with your hand. Starting up with your back straight. Slowly exhale and try to bring your chest to the knee of your outstretched leg. Hold, then repeat on the other side for 15 seconds.



8

Calf / Achilles Stretch

Lean against a wall with your left leg in front of the right and your arms forward. Keep your right leg straight and the left foot on the floor; then bend the left leg and lean forward by moving your hips toward the wall. Hold, then repeat on the other side for 15 seconds.



ASSEMBLY PARTS

Unpack the box in a clear, open area. Review the **List of Assembly Parts** below. Check and make sure all assembly parts are present and in good condition. Do not dispose of the packing material until the assembly process is completed.

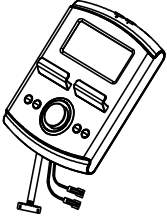
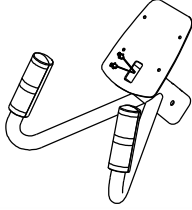
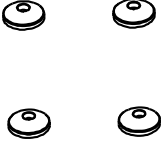
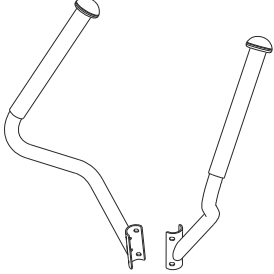
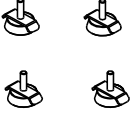
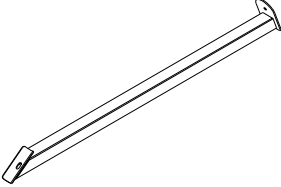
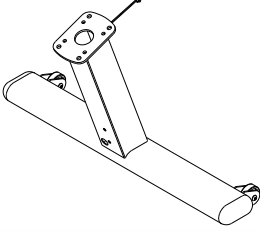
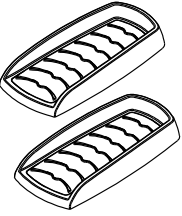
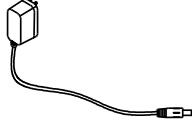
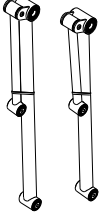
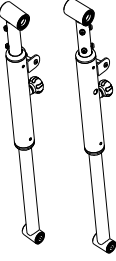
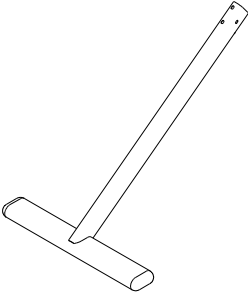
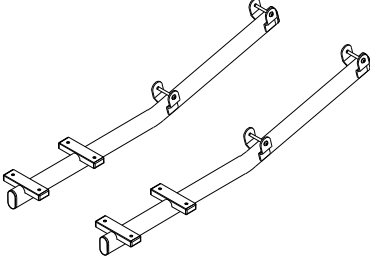
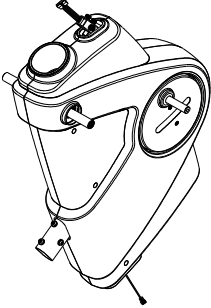
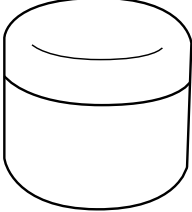
Console	#32 Fixed Handlebar	Tube Cap	#44 & #45 (L & R) Upper Handlebar
			
#27 Leveler	#30 Support Tube		#28 Front Stabilizer
			
#55 Pedal	#63 Adaptor (9V / 1.5A)	#99 & #36 Swing Arm (L & R)	#47 & #48 Pivoting Arm (L & R)
			
#25 Rear Stabilizer	#58 Pedal Support Arm		#1 Main Frame
			
Tub of Grease (For use on Page 10 - Step B)			
			



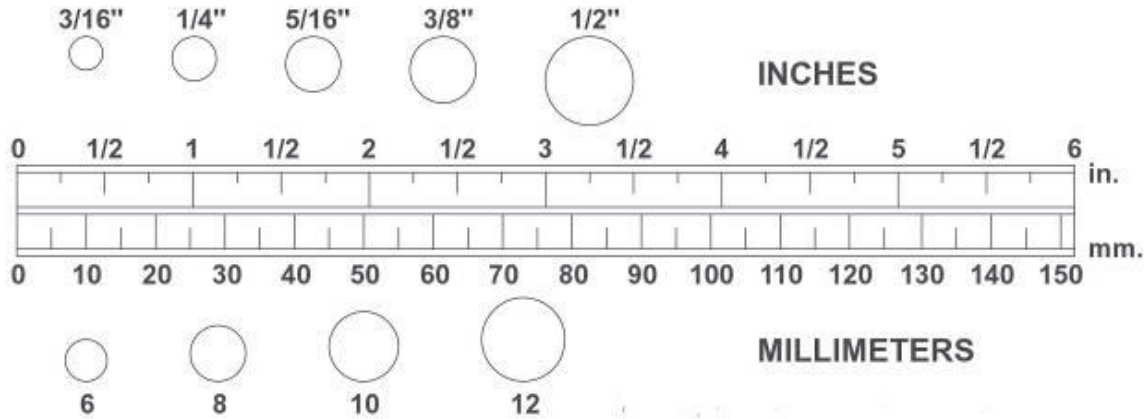

HARDWARE IDENTIFICATION CHART

Review the “**List of Hardware Kit**” below. This chart is provided to help identify the hardware used during the assembly process. Place the washers, the end of bolts, or screws on the circles to check for the correct diameter. Use the small scale to check the length of the bolts and screws.

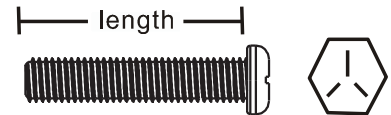

NOTICE: The length of all bolts and screws except those with flat heads is measured from below the head to the end of the bolt or screw. Flat head bolts and screws are measured from the top of the head to the end of the bolt or screw

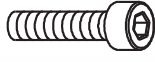
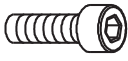

HARDWARE KIT	Part No. and Description	QTY
	65 Lock Washer (M8)	3 pcs
	66 Washer (8x16x2.0t)	3 pcs
	67 Washer (8x30x3.0t)	4 pcs
	82 Screw, Pan Head (M5xp0.8x15mm)	4 pcs
	85 Bolt, Socket Head (M8xp1.25x20mm)	3 pcs
	86 Bolt, Socket Head (M8xp1.25x30mm)	8 pcs
	94 Bolt, Socket Head (M8x1.25x25mm)	4 pcs

BEFORE YOU BEGIN

Always consult with your doctor to confirm you are healthy enough to begin an exercise program.

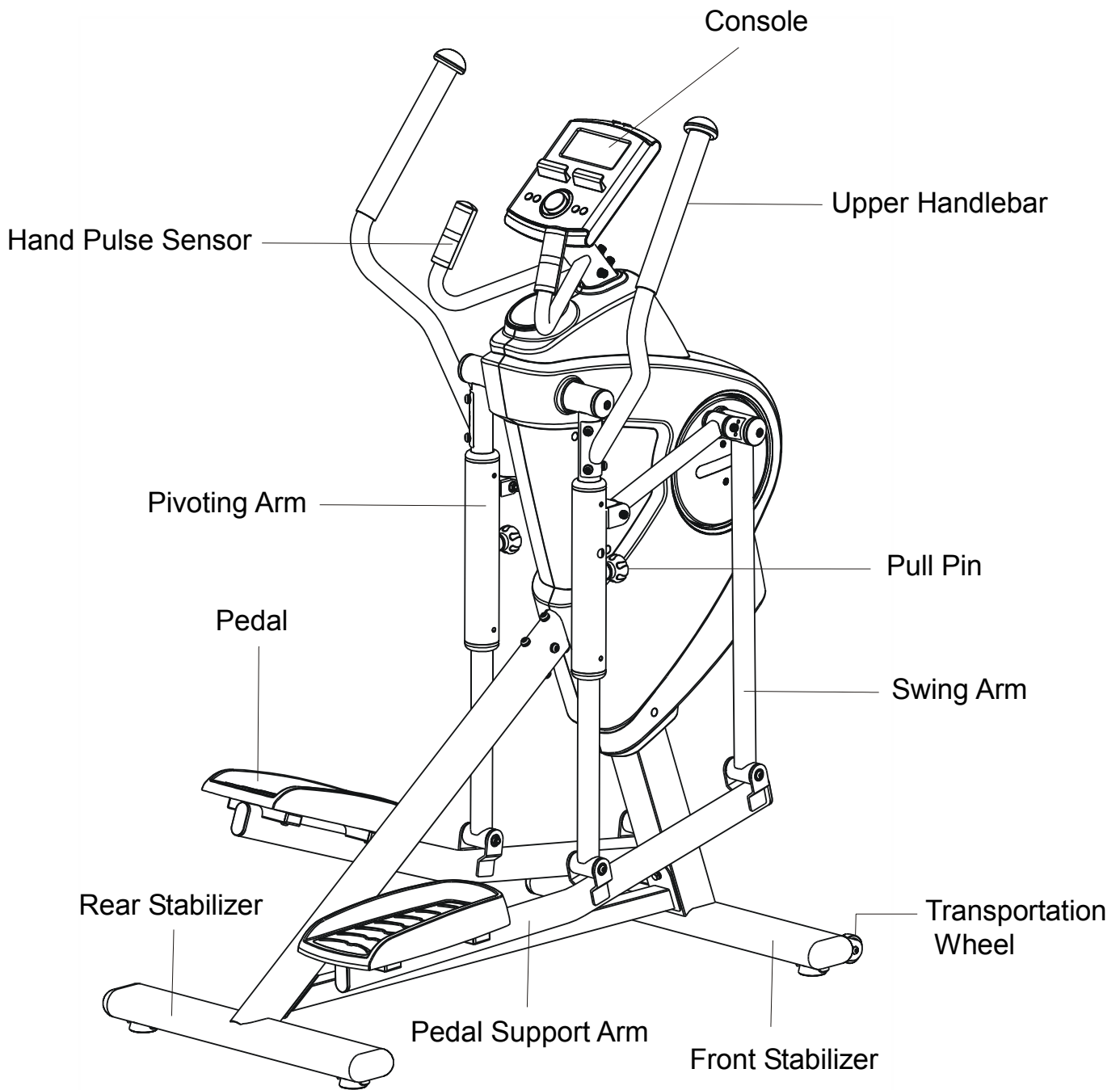

THE FOLLOWING TOOLS ARE INCLUDED FOR ASSEMBLY:

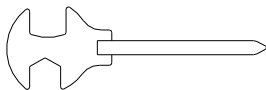

**MULTI WRENCH TOOL W/
PHILLIPS SCREWDRIVER
(65mm)**

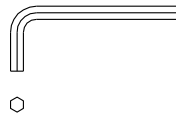

**ALLEN WRENCH
(6 mm)**



**SOCKET WRENCH
(17 mm)**

ASSEMBLY INSTRUCTIONS

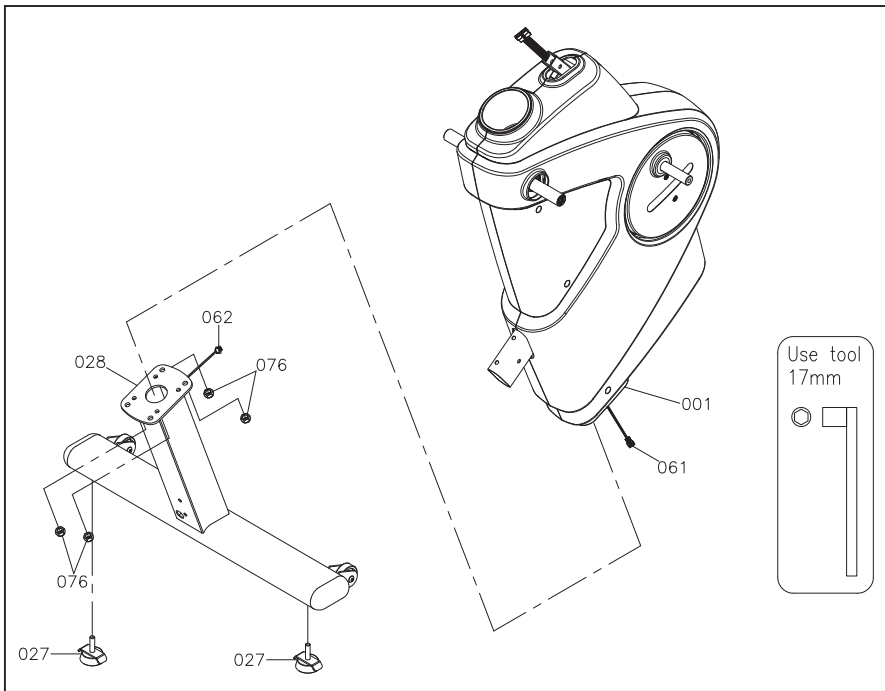

Detailed Lever- drawing 1

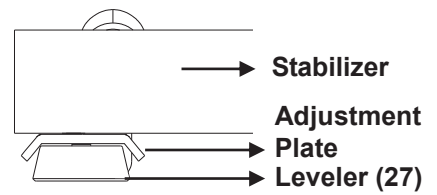

Detailed Lever- drawing 2

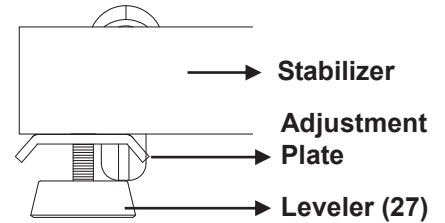

Adjustment Plate

LEVELING NOTE: After placing the item in the intended location, check the stability of the item. If the equipment is not level, review the following directions:

Loosen the **Leveler (27)** to make the **Adjustment Plate** become less tight.

Use one hand to adjust the **Leveler (27)** for leveling.

Once the machine is level, tighten the **Adjustment Plate** securely against the **Stabilizer (28)** as shown in drawing 2 above.

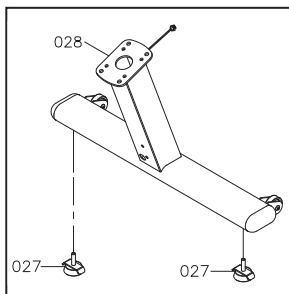

STEP 1 – Leveler Assembly

A) Follow the drawings to attach 2pcs **Levelers (27)** under the **Front Stabilizer (28)**. Be sure to tighten the **Levelers (27)** securely until screw lines are eliminated as the drawing 1 shows on the top right corner.

NOTE: If the item is not level, review the **LEVELING NOTE** on the right side of this page.

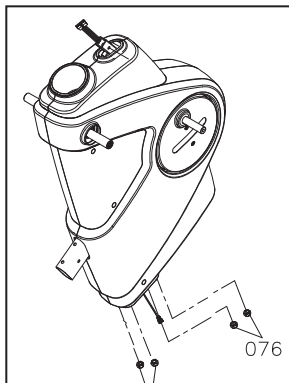

STEP 2 – Front Stabilizer Assembly

A) Remove 4pcs **Nylon Nuts (76)** from the **Main Frame (1)**.

B) Place the **Main Frame (1)** on the original packing Styrofoam.

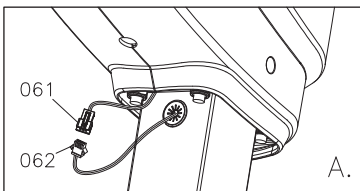

C) Then attach the **Front Stabilizer (28)** (with the wheels face up) to the **Main Frame (1)** and fully tighten 4pcs **Nylon Nuts (M10xp1.5)(76)**.

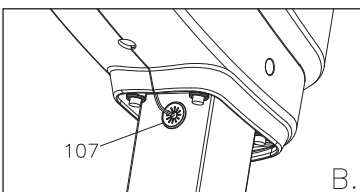

D) Refer to left, attach the **Lower Adaptor Connection Wire (62)** into the **Middle Adaptor Connection Wire (61)**.

E) Then neatly tuck the wires (**61 & 62**) into the hole of the **Snap Bushing (107)**.

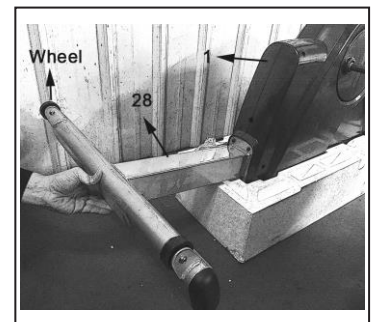

ASSEMBLY INSTRUCTIONS

STEP 3 – Rear Stabilizer Assembly

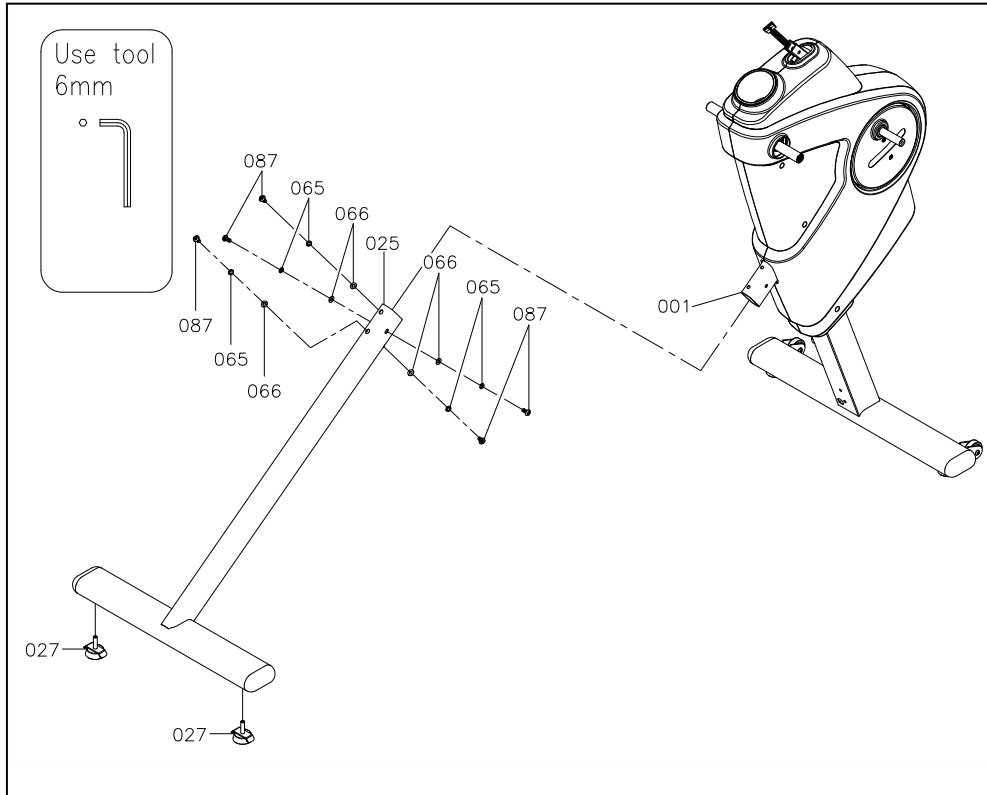

A) Refer to below picture, attach 2pcs **Levelers (27)** under the **Rear Stabilizer (25)** and make sure they are level on the floor.

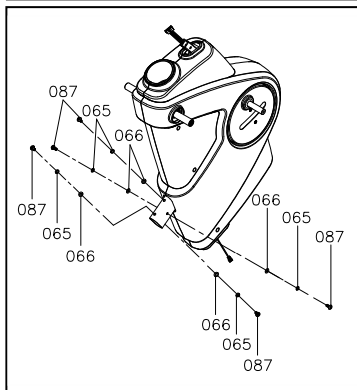
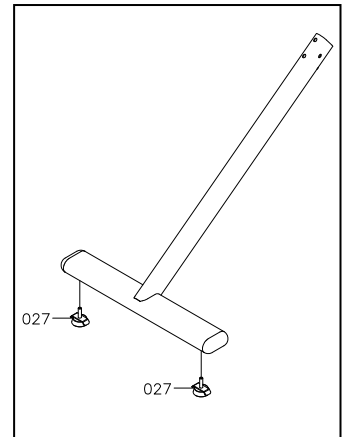

NOTE: Refer to left picture, 5pcs **Washers (8x16x2.0t)(66)**, 5pcs **Lock Washers (M8)(65)**, 5pcs **Bolts, Button Head (M8xp1.25x16mm)(87)** have been preassembled on the rear of the **Main Frame (1)**.

B) Remove the above bolts and washers from the **Main Frame (1)**.

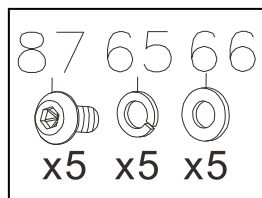

NOTE: 2 Person Step

C) Refer to the picture on the left, carefully turn the elliptical over and place the front main frame onto the Styrofoam (which originally covered the front side of the main frame).

Attach the **Rear Stabilizer (25)** to the **Main Frame (1)** and loosely secure with 5pcs **Washers (66)**, 5pcs **Lock Washers (65)**, 5pcs **Bolt (87)**. **NOTE:** Do not fully tighten the **Bolts (87)** until Step 5; part C.

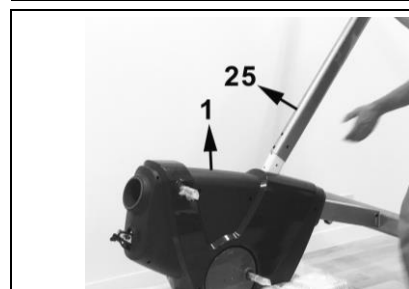

ASSEMBLY INSTRUCTIONS

STEP 4 – Support Tube Assembly

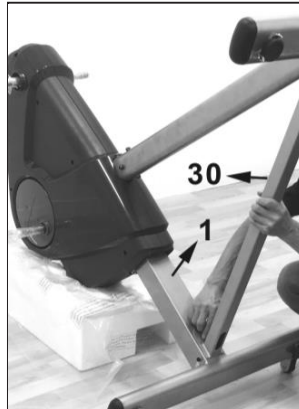
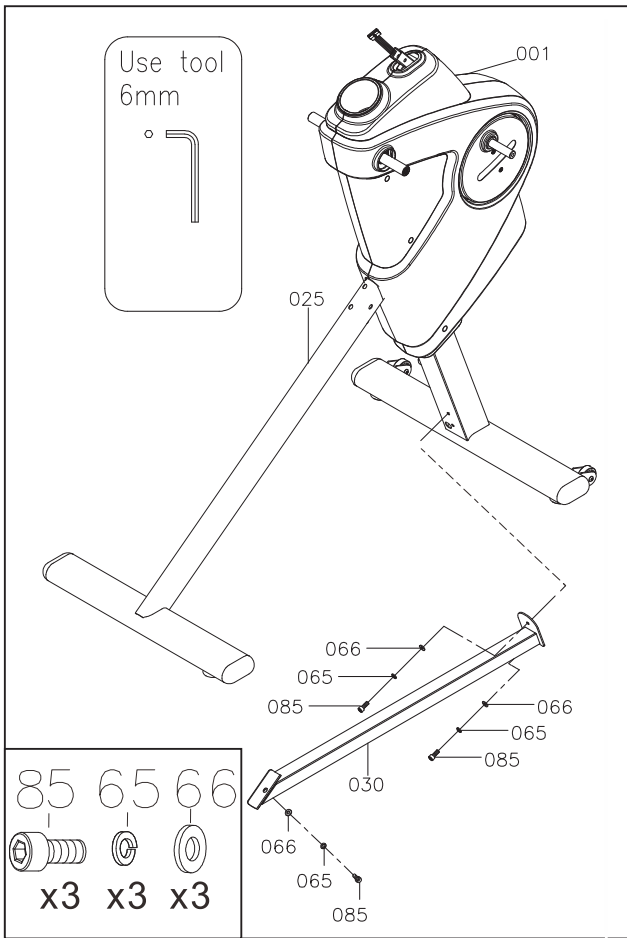

A) Attach the **Support Tube (30)** to the **Main Frame (1)** by loosely attaching 1pc **Bolt, Socket Head (M8x1.25x20mm) (85)**, 1pc **Lock Washer (M8) (65)**, 1pc **Washer (8x16x2.0t) (66)**.

NOTE: Please do not fully tighten Bolt (85) until **Part A** of Step 5.



B) Loosely attach 1pc **Socket Bolt (85)**, 1pc **Lock Washer (65)** and 1pc **Washer (66)** into the bottom of the **Support Tube (30)**.

NOTE: Please do not fully tighten Bolt (85) until **Part A** of Step 5.

C) Attach **Support Tube (30)** to the **Rear Stabilizer (25)**. Fully tighten 1pc **Socket Bolt (85)**, 1pc **Lock Washer (65)** and 1pc **Washer (66)** into the top of the **Support Tube (30)**.

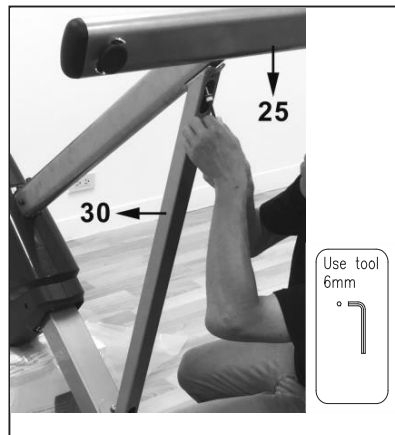

ASSEMBLY INSTRUCTIONS

STEP 5 – Tighten All Bolts

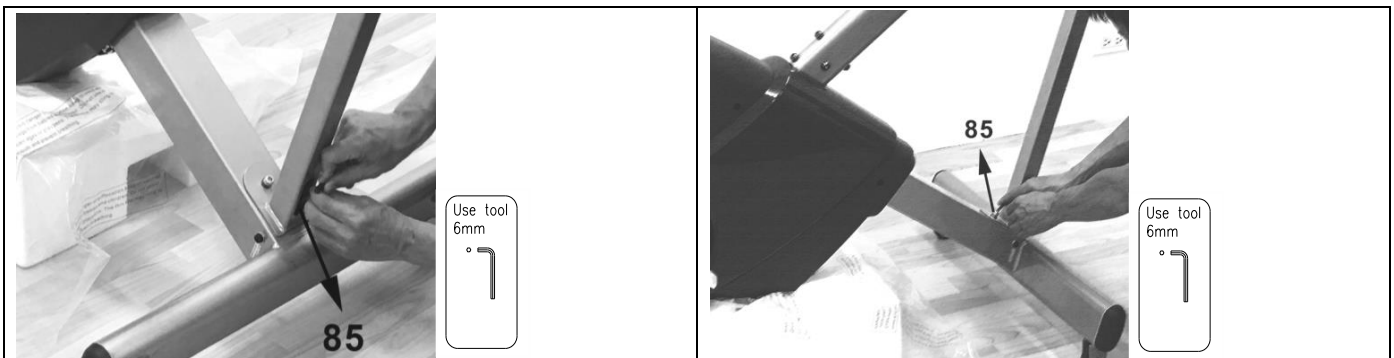
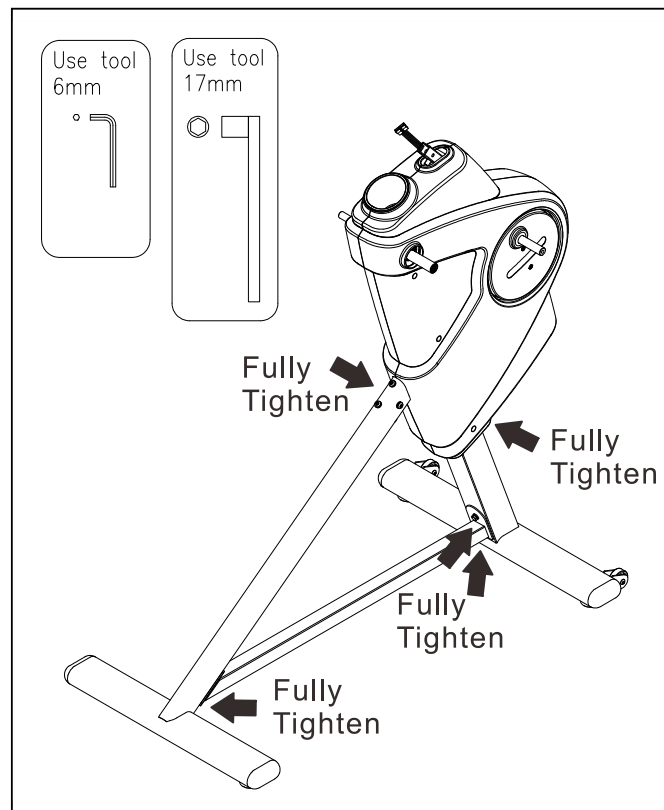

A) Refer to above photos. Tighten the bolts at the bottom of **Support Tube (30)** and fully tighten 2pcs **Socket Bolts (85)**, 2pcs **Lock Washers (65)** and 2pcs **Washers (66)**.

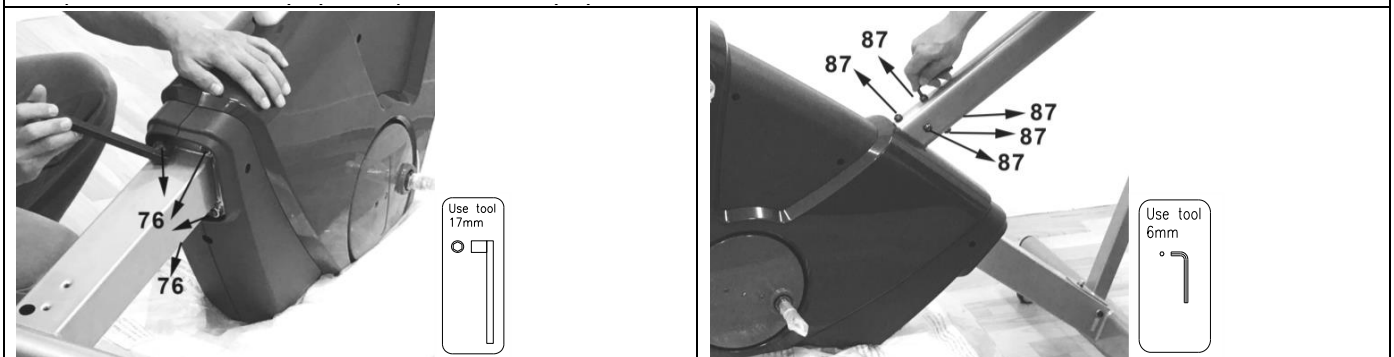

B) Go back to the upper side of the **Front Stabilizer (28)** and fully tighten 4pcs **Nylon Nuts (76)**.

C) Go back to the front of the **Rear Stabilizer (25)** and fully tighten 5pcs **Washers (66)**, 5pcs **Lock Washers (65)**, 5pcs **Bolts (87)**.

ASSEMBLY INSTRUCTIONS

STEP 6 – Swing Arm Assembly

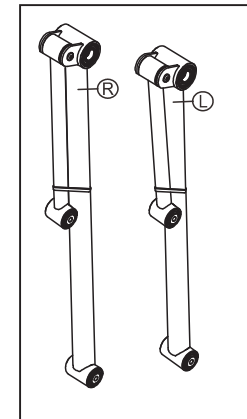
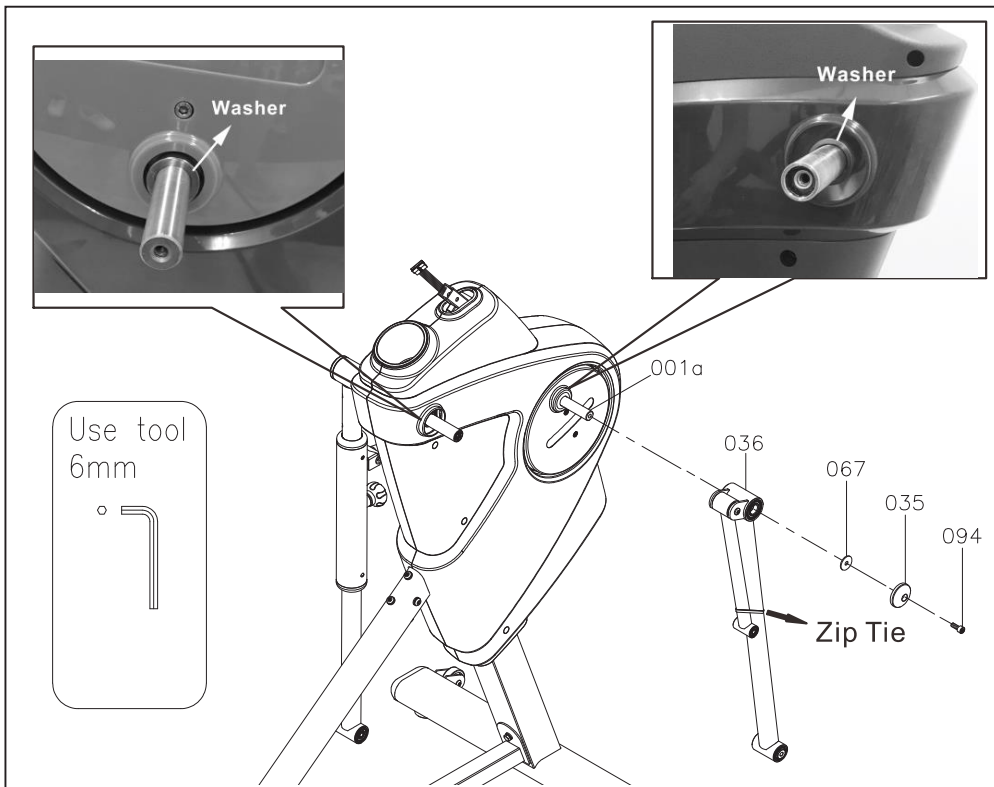

A) There is an “R” & “L” decal on the **Swing Arm (99, 36)**.

B) Find the “Tub of Grease” and open. Apply a small amount of grease to both Axles (001a and 001b) on both sides. Wipe off any excess grease after sliding on Swing Arm and Pivoting Arm.

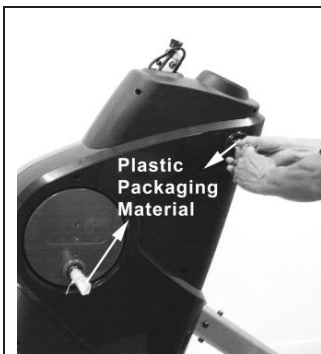

C) Refer to left, gently remove plastic packaging material from two Axles.

NOTE: Be sure not to remove the washers that are already installed inside while removing packaging material.

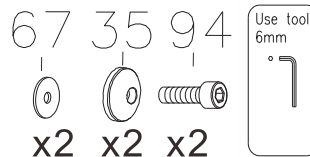
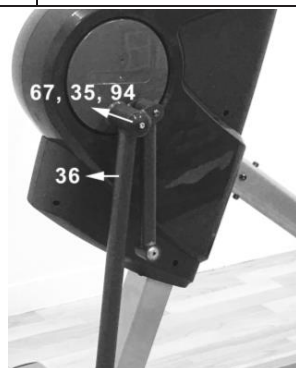
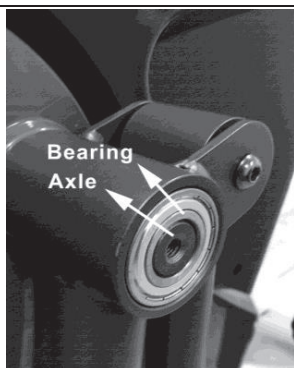

D) Refer to left pic, make sure the Axle surface is flush with the Bearing surface before tightening.

E) Slide the **Right Swing Arm (36)** onto the **Crank Axle (001a)** and fully tighten 1pcs **Washer (8x30x3.0t) (67)**, 1pcs **Tube Cap (35)** and 1pcs **Bolt, Socket Head (M8x1.25x25mm) (94)**.

F) Cut the zip tie from the **Swing Arm (36)**.

G) Repeat the above procedure for the other side.

ASSEMBLY INSTRUCTIONS

STEP 7 – Pivoting Arm & Crank Linkage Assembly

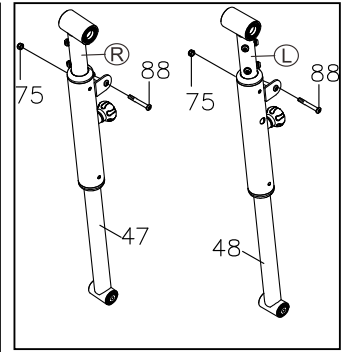
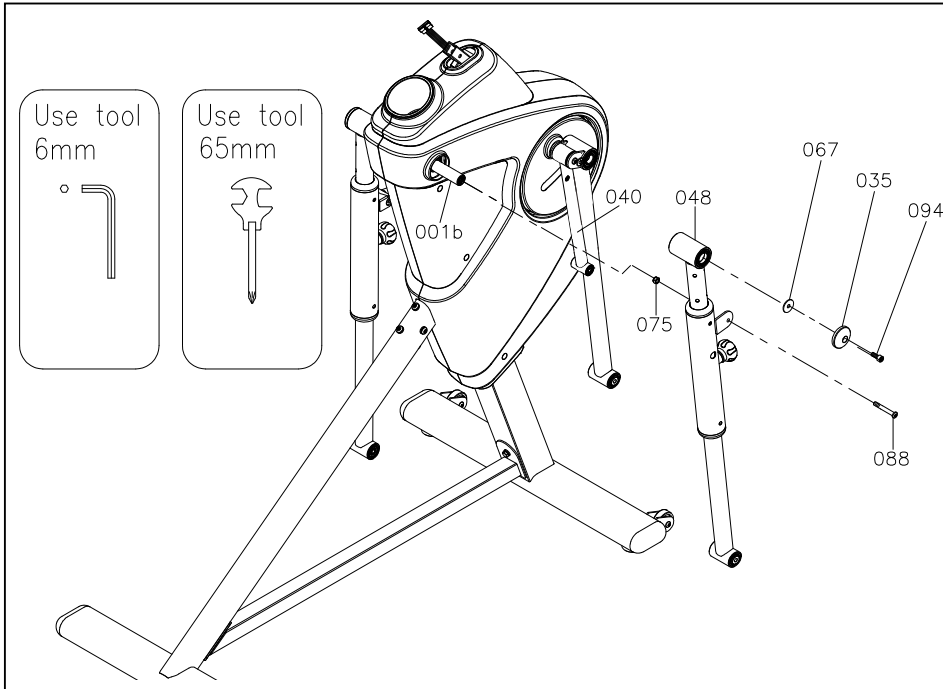

A) There is an "R" & "L" decal on the **Pivoting Arm (47, 48)**.

B) 2pcs **Bolts, Socket Head (M8x1.25x65mm) (88)** and 2pcs **Nylon Nuts (M8x1.25) (75)** have been preassembled into the **Right Pivoting Arm (48)**.

C) Remove the above bolts and nuts before continuing the assembly process.

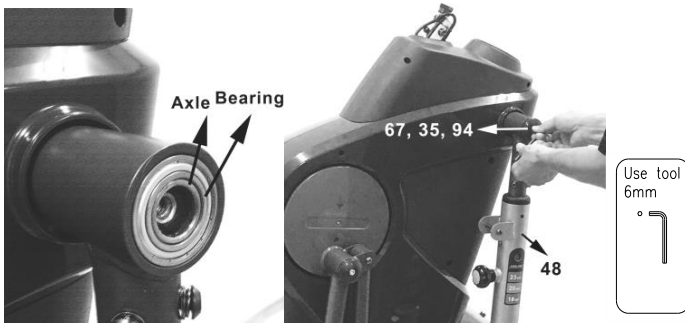

D) Refer to left picture, make sure the Axle surface is flush with the Bearing surface before tightening.

E) Slide the **Pivoting Arm (48)** onto the **Frame Axle (001b)** and fully tighten 1pcs **Washer (8x30x3.0t) (67)**, 1pcs **Tube Cap (35)** and 1pcs **Bolt, Socket Head (M8x1.25x25mm) (94)**.

F) Repeat the above same procedure for the other side.

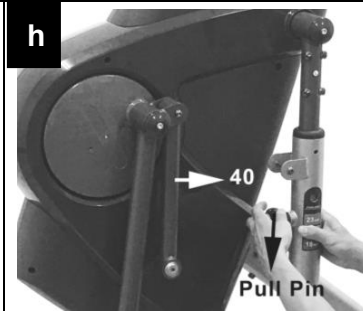
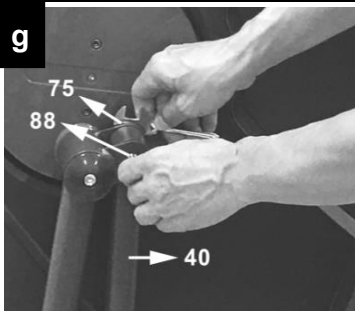
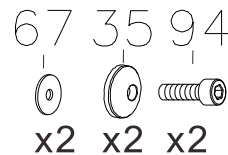

G) Refer to left, in order to assemble the **Linkage (40)**, first slightly loosen **Bolt (88)** and **Nylon Nut (75)** from the **Crank Linkage (40)**.

H) Release the **Pull Pin (54)**.

I) Next, attach the **Crank Linkage (40)** to the **Pivoting Arm (48)** and fully tighten 1pcs **Bolt (88)** and 1pcs **Nylon Nut (75)**.

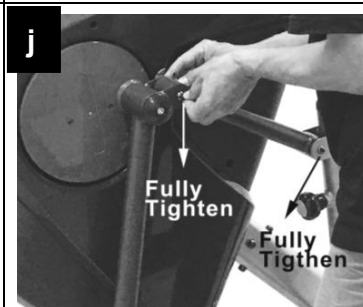
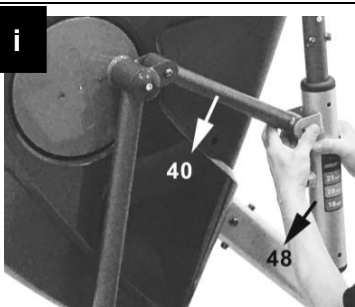
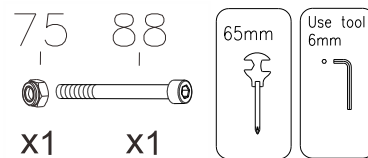

J) Go back to **Crank Linkage (40)** and fully tighten 1pcs **Bolt (88)** and 1pcs **Nylon Nut (75)**.

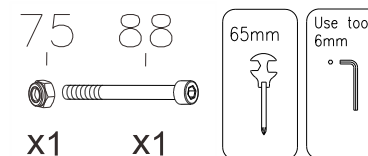

K) Repeat the above procedure for the other side.

ASSEMBLY INSTRUCTIONS

STEP 8 – Pedal Support Arm Assembly

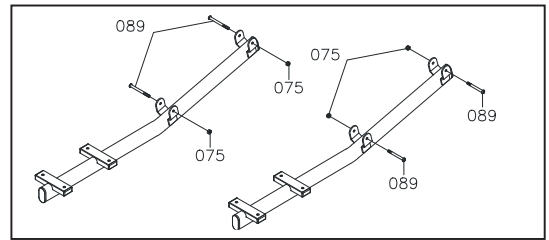
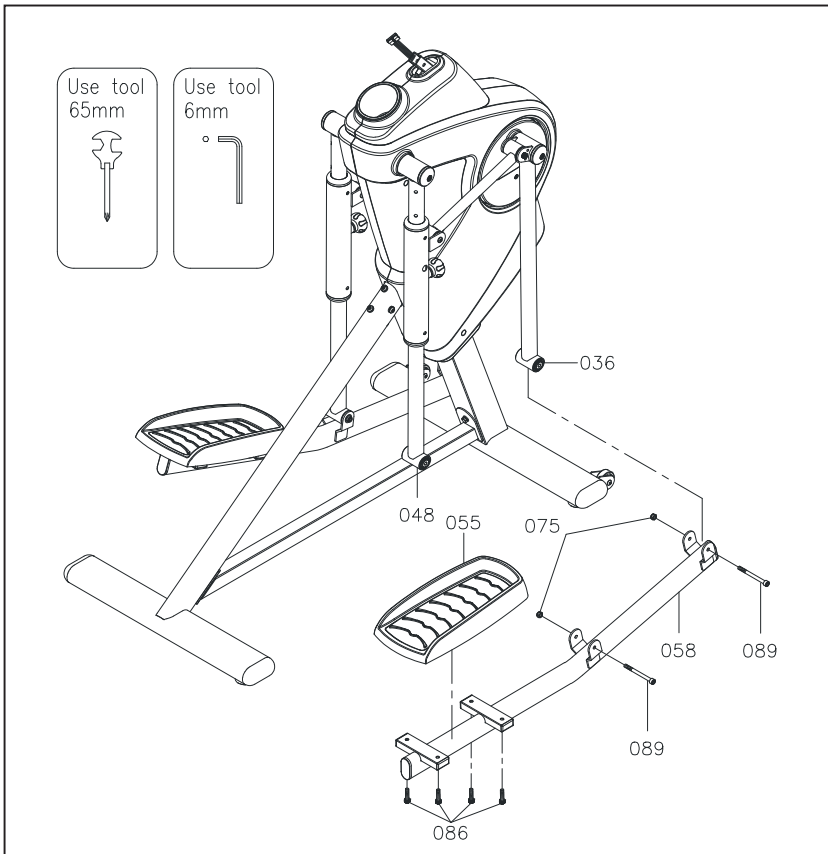

NOTE: Refer above, 4pcs Nylon Nut (M8xp1.25)(75), 4pcs Bolts, Socket Head (M8xp1.25x80mm)(89) have been preassembled on the Pedal Support Arm (58).

A) Remove above bolts and nuts from the Pedal Support Arm (58).

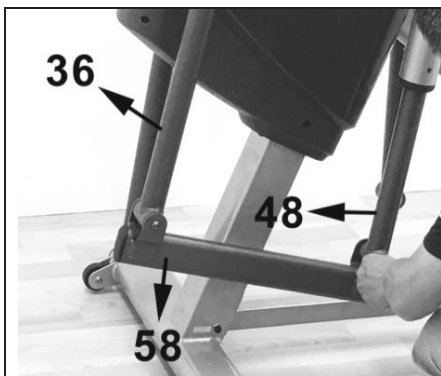
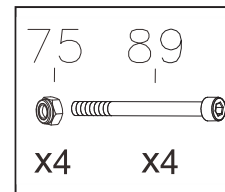

Attach the Pedal Support Arm (58) to the Swing Tube (36) & Pivoting Arm (48) using 2pcs Bolts (89) and 2pcs Nylon Nuts (75). Tighten fully.

C) Repeat the above procedure for the other side.

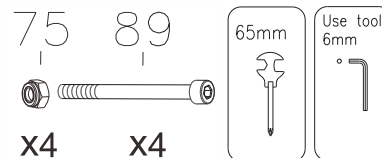

STEP 9 – Pedal Assembly

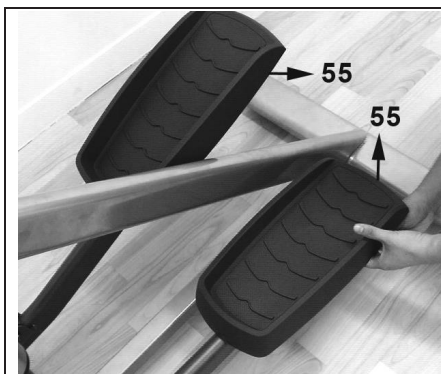

A) Put the Pedal (55) on the Pedal Support Arm (58) and fully tighten 4pcs Bolts, Socket Head (M8xp1.25x30mm)(86).

B) Repeat the above procedure for the other side.

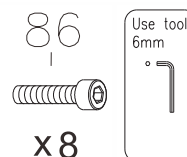

ASSEMBLY INSTRUCTIONS

STEP 10 – Fixed Handlebar Assembly

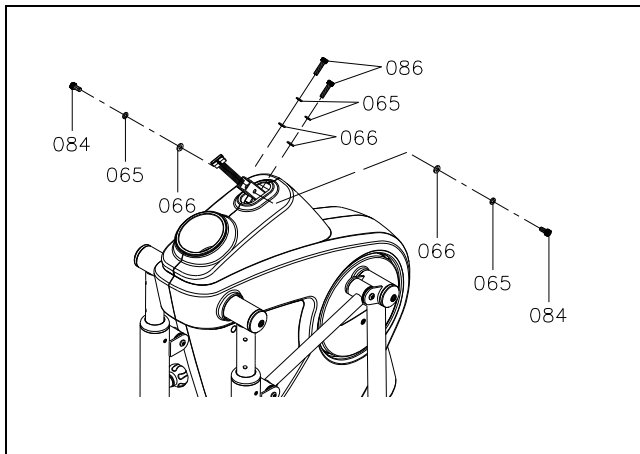
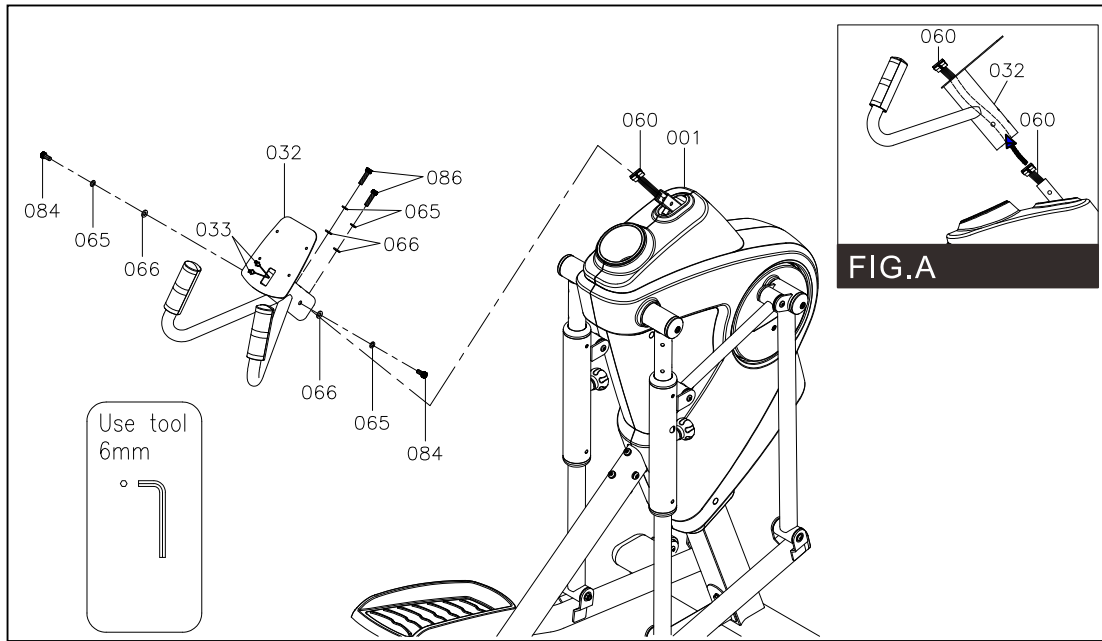

NOTE: See Image on left; 4pcs **Washers (8x16x2.0t) (66)**, 4pcs **Lock Washers (M8) (65)**, 2pcs **Bolts, Socket Head (M8xp1.25x16mm) (84)**, 2pcs **Bolts, Socket Head (M8xp1.25x30mm) (86)** have been preassembled on the **Main Frame (1)**.

A) Remove these bolts and washers from the **Main Frame (1)** before continuing.

66	65	84	66	65	86
x2	x2	x2	x2	x2	x2

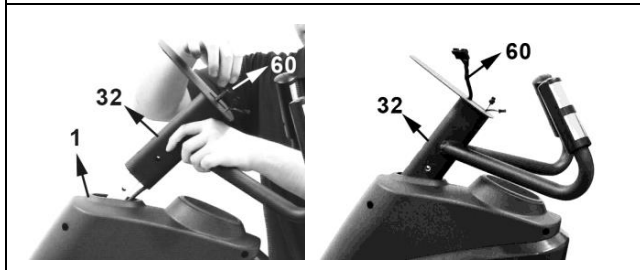

B) Follow **FIG.A**, gently insert the **Upper Connection Wire (60)** into the **Fixed Handlebar (32)**.

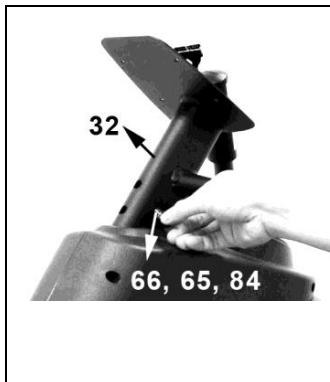

C) Attach 1pcs **Washer (66)**, 1pcs **Lock Washer (65)**, 1pcs **Bolt (84)** on each side of the **Handlebar (32)**.

NOTE: Please don't fully tighten at this time.

66	65	84
x2	x2	x2

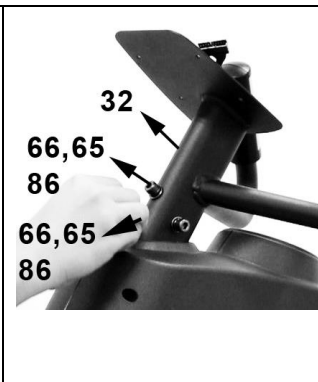

D) Attach 2pcs **Washers (66)**, 2pcs **Lock Washers (65)**, 2pcs **Bolts (86)** on front side of the **Handlebar (32)**.

NOTE: Please don't fully tighten at this time.

66	65	86
x2	x2	x2

ASSEMBLY INSTRUCTIONS

STEP 11 – Console Assembly

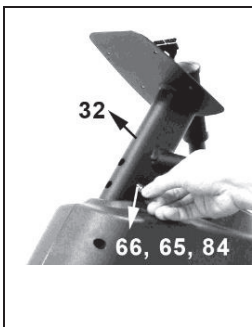
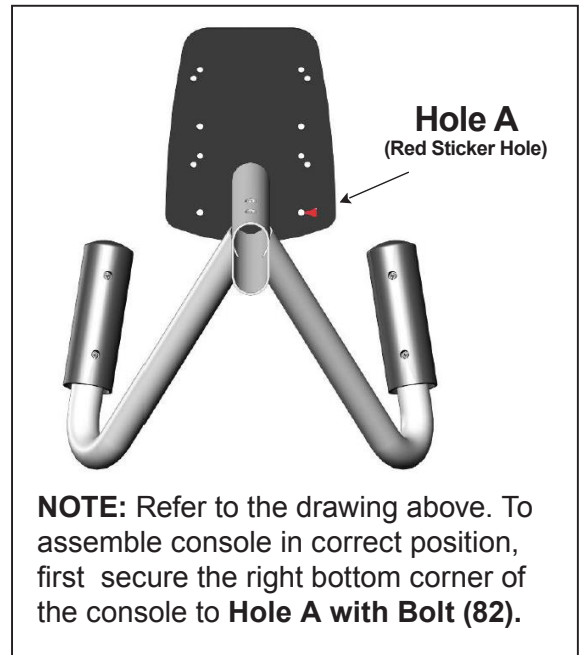
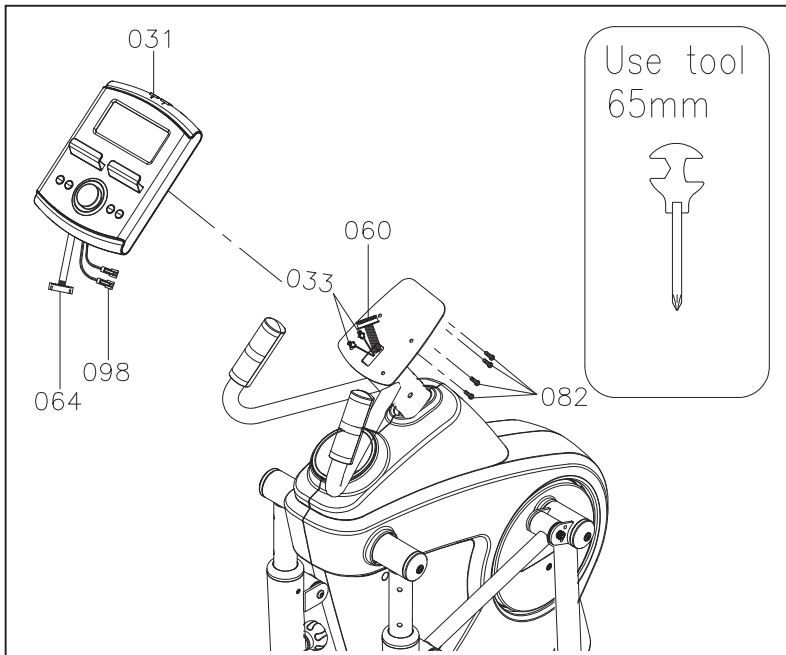

A) Go back to the side of **Handlebar (32)** and fully tighten 2pcs **Washers (66)**, 2pcs **Lock Washers (65)**, 2pcs **Bolts (84)**.

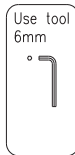

66 65 84
x2 x2 x2

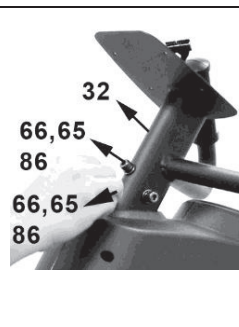

B) Go back to the front of **Handlebar (32)** and fully tighten 2pcs **Washers (66)**, 2pcs **Lock Washers (65)**, 2pcs **Bolts (86)**.

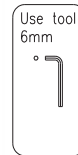

66 65 86
x2 x2 x2

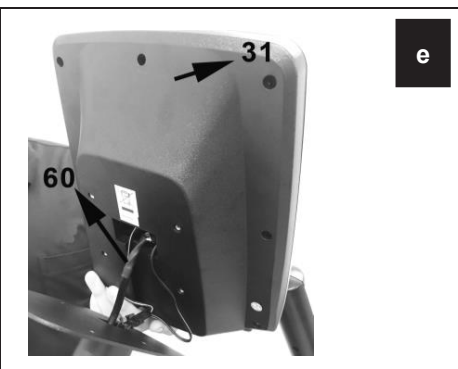
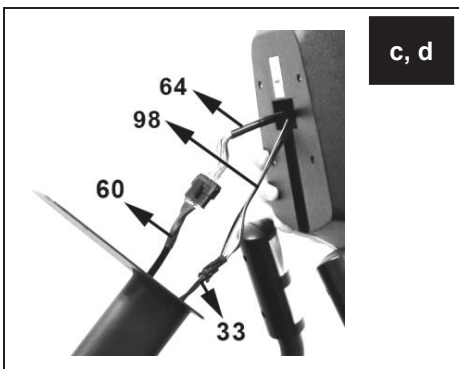

C) Connect the **Console Wire (64)** to the **Upper Connection Wire (60)**. **NOTE:** Be careful not to pinch the wires.

D) Connect the **Console Wire (98)** to the **Upper Pulse Sensor Wire (33)**. **NOTE:** Be careful not to pinch the wires.

E) First slide the **Upper Connection Wire (60)** into the **Console (31)**.

F) Then slide the rest of wires into **Fixed Handlebar (32)**.

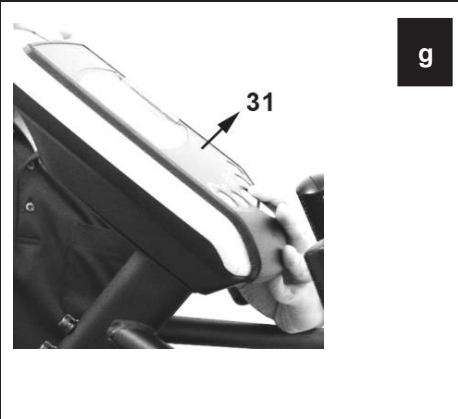
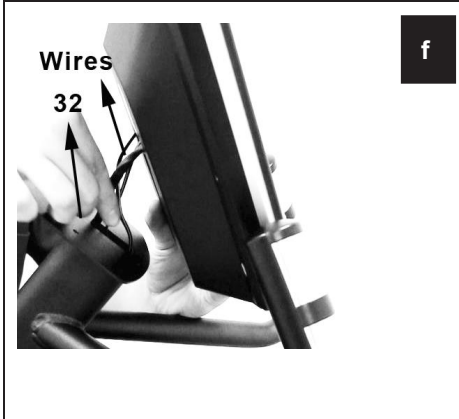

G) Follow the above red arrow sticker to gently attach the **Console (31)** to the **Fixed Handlebar (32)** by fully tightening with 4pcs **Screws, Pan Head (M5xp0.8x15mm)(82)**.

82
x4

ASSEMBLY INSTRUCTIONS

STEP 12 – Upper Handlebar Assembly

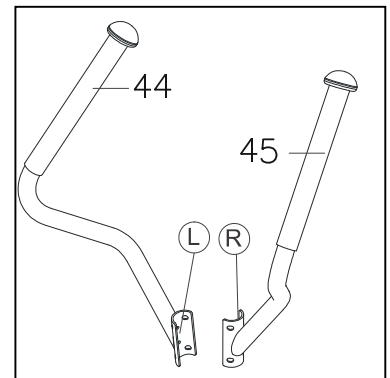
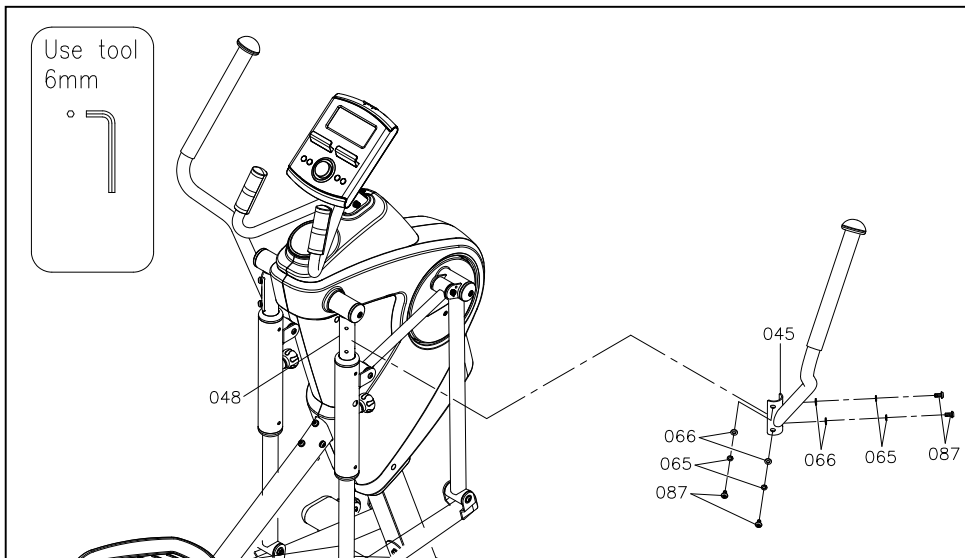

A) There is an “R” & “L” decal on the **Upper Handlebar (44, 45)**.

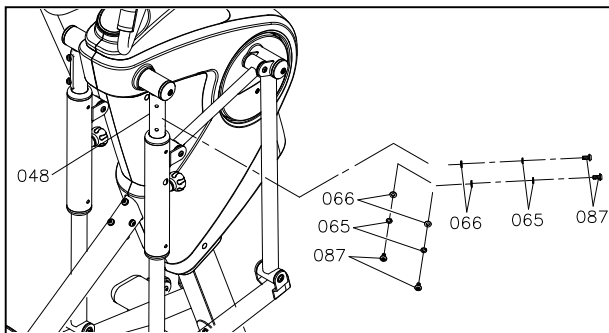

B) NOTE: 4pcs **Bolts, Button Head (M8×p1.25×16mm) (87)** and 4pcs **Lock Washers (M8) (65)** and 4pcs **Washers (8x16x2.0t) (66)** have already been preassembled into the **Pivoting Arm (48)**.

C) Go ahead and remove these bolts and washers from the **Pivoting Arm (48)**.

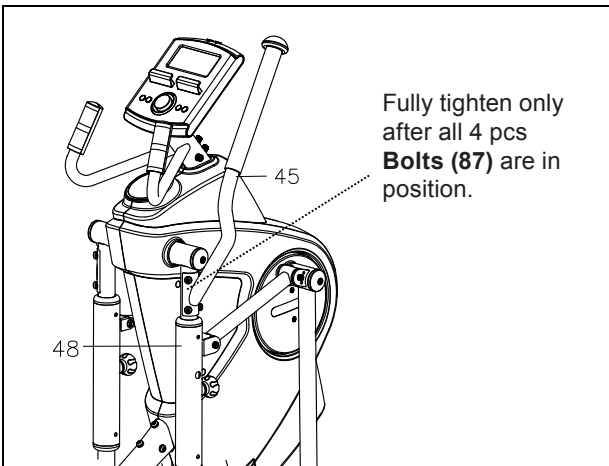
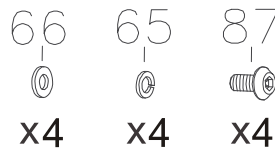

D) Attach the **Right Upper Handlebar (45)** to the **Right Pivoting Arm (48)** and loosely secure with 4pcs **Bolts (87)**, 4pcs **Lock Washers (65)** and 4pcs **Washers (66)**.

Once all 4 pcs **Bolts (87)**, **Lock Washers (65)** and **Washers (66)** are in position, fully tighten all **Bolts (87)**, **Lock Washers (65)** and **Washer (66)**.

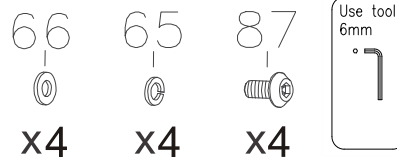

E) Repeat the above same procedure for the left side.

F) Finish the assembly, make sure that all parts are tightened before you use the equipment.

G) Make sure the item is level on the floor, if not, please adjust and fully tighten **Levelers (27)**.

STEP 13 – AC Adaptor

A) Connect the **Adaptor (63)** to the connector located on the left side of the **Main Frame (1)**.

B) Plug the **Adaptor (63)** into an electrical outlet to power on the console.

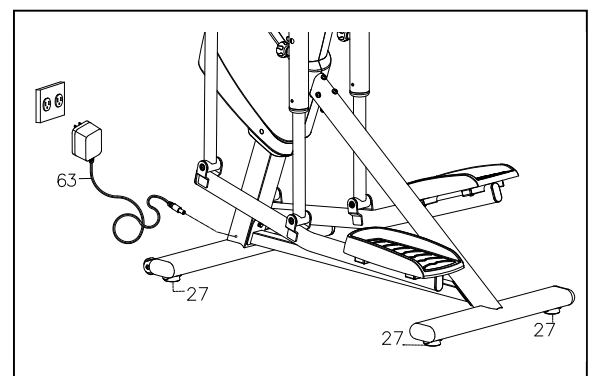

OPERATION INSTRUCTIONS

How To Move The Item Safely

Lift the **Rear Stabilizer (25)** bar up with two hands and roll the machine to the desired location.

CAUTION: HEAVY – 2 person lift.

- Make sure the floor is level while rolling the elliptical.
- Be mindful of the surface you roll this across; it is heavy and can cause damage to softer wood floors and brittle tile. Please use common sense!

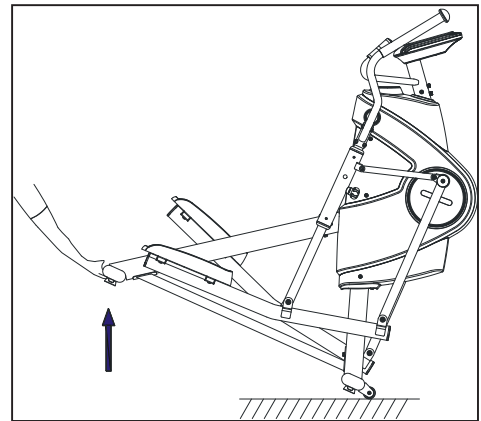

How To Adjust The Stride Length

The Elliptical Trainer is equipped with three adjustable stride lengths from 18" (457mm) to 23" (584mm)

A) To adjust the stride length, loosen and pull the **Right Pull Pin (54)**. Move the **Right Telescoping Bar (10)** to the proper desired position (ORANGE position for 23", BLUE position for 20", WHITE position for 18").

B) Release the **Right Pull Pin (54)** and make sure the pin on the knob locks into the adjustment hole in the **Right Telescoping Bar (10)**.

C) Repeat the above process to adjust the stride length on the left side.

IMPORTANT NOTE!

1. Always adjust the Right & Left Telescoping Bar (10) to the same height.
2. Securely tighten the Right & Left Pull Pin (54) prior to every workout. Check this each time!

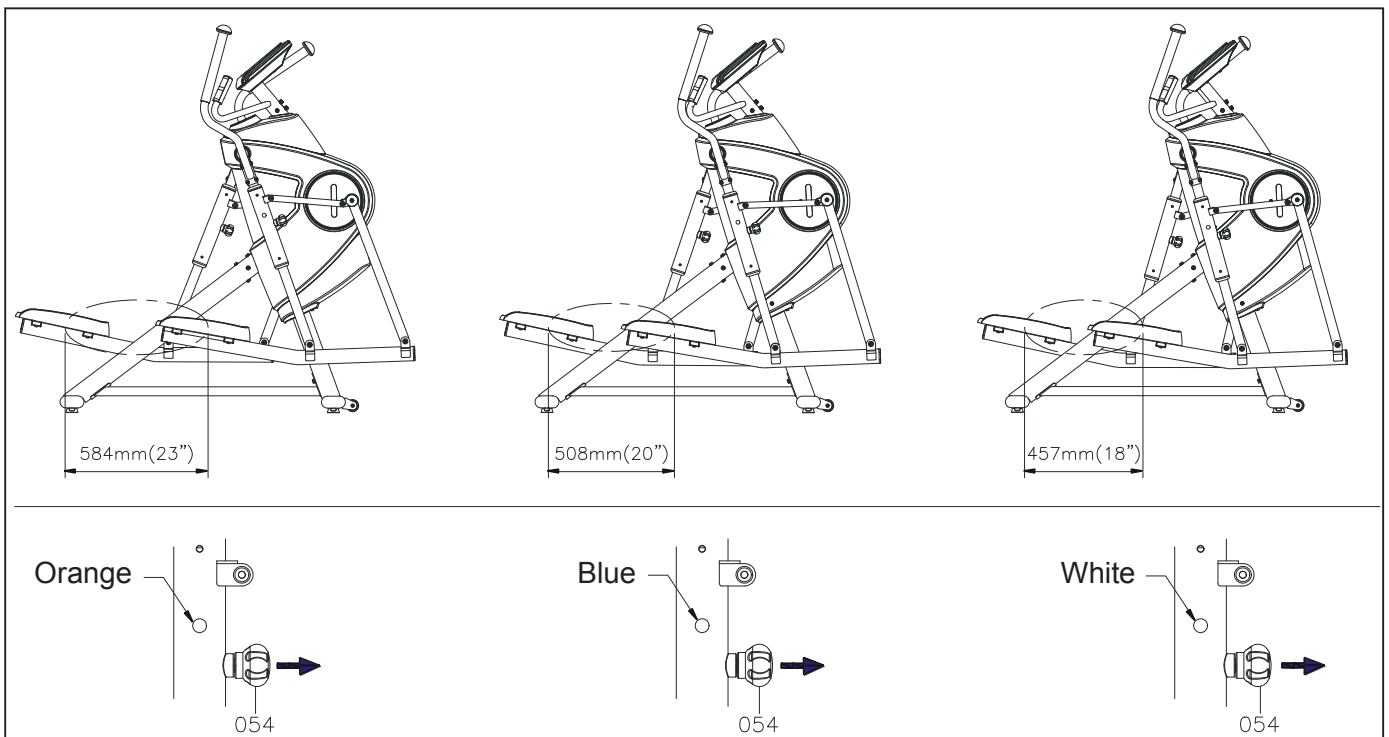

CONSOLE INSTRUCTIONS

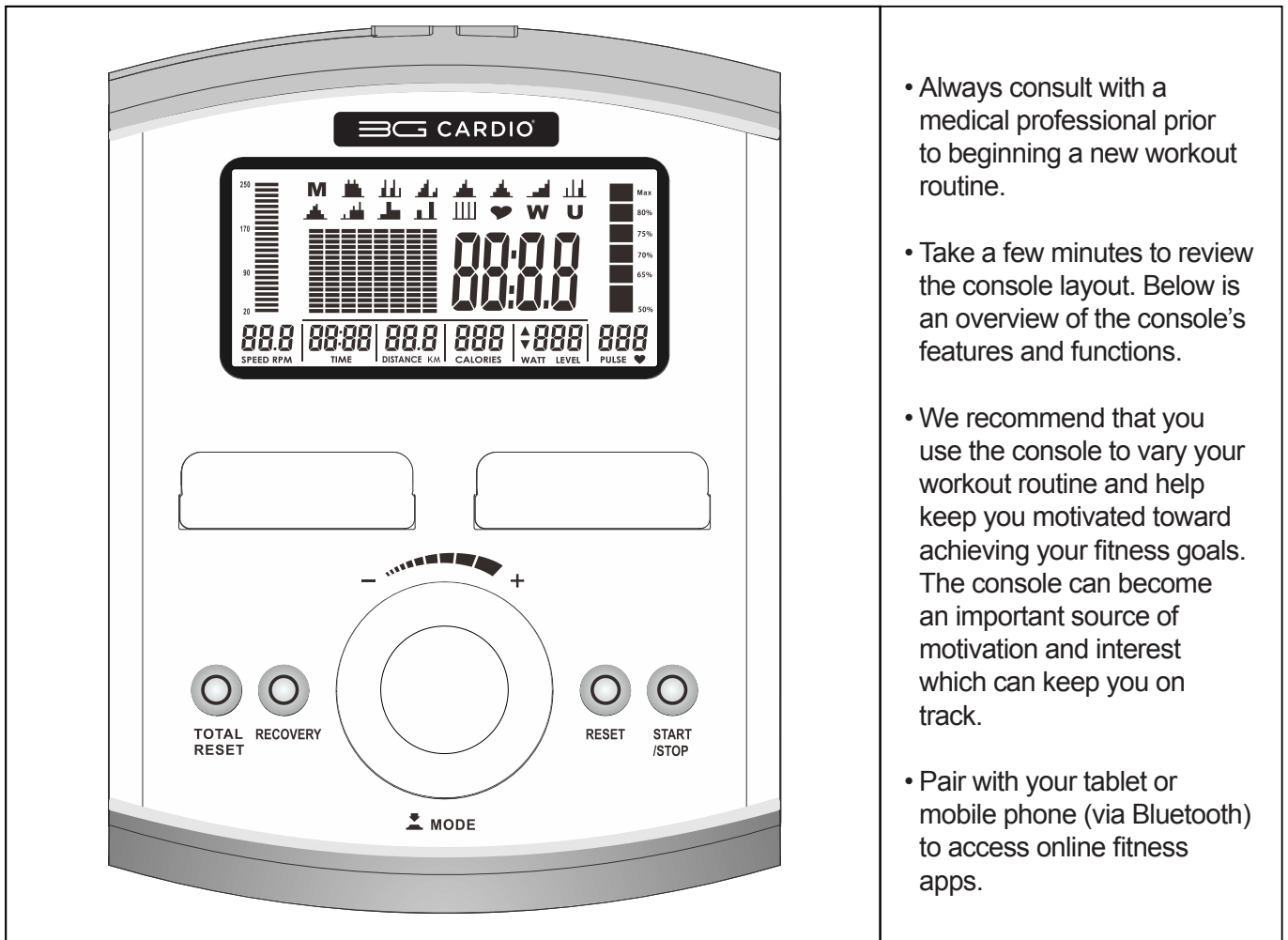

- Always consult with a medical professional prior to beginning a new workout routine.
- Take a few minutes to review the console layout. Below is an overview of the console's features and functions.
- We recommend that you use the console to vary your workout routine and help keep you motivated toward achieving your fitness goals. The console can become an important source of motivation and interest which can keep you on track.
- Pair with your tablet or mobile phone (via Bluetooth) to access online fitness apps.

• Power ON

A) Make sure the power adaptor is correctly plugged into a wall outlet.

B) Press **TOTAL RESET** button to turn on and/or reset the console.





• Power Off

The console will automatically shut off after 4 minutes of inactivity.

• Program List





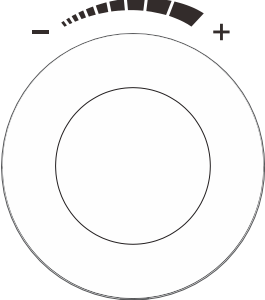

M P1 MANUAL	 P2 GLUTE BLAST	 P3 PHYSICAL	 P4 RAMP
 P5 PLATEAU CLIMB	 P6 MOUNTAIN CLIMB 1	 P7 FITNESS TEST	 P8 IRON MAN
 P9 MOUNTAIN CLIMB 2	 P10 FAT BURN	 P11 HILL CLIMB	 P12 VALLEY
 P13 INTERVAL	 P14 H.R.C.(55%, 75%, 90%, T.H.R.)	W P15 WATT CONTROL	U P16 USER

CONSOLE INSTRUCTIONS – CONSOLE BUTTONS

 <p style="text-align: center;">START /STOP</p>	<p>A) Press START/STOP to begin your exercise.</p> <p>B) Press START/STOP again to stop and pause all functions during your exercise program.</p> <p>C) PAUSE MODE: Press START/STOP to enter into PAUSE MODE.</p>
 <p style="text-align: center;">RESET</p>	<p>A) In Pause mode, press the RESET button once to return to the main menu.</p> <p>B) Hold the RESET button for more than 2 seconds to restart the console.</p>
 <p style="text-align: center;">RECOVERY</p>	<p>A) PULSE RECOVERY button measures how quickly you return to a resting heart rate after exercising. You can use this mode to measure improvements in your heart strength. (Consult with your doctor prior to any intense physical fitness).</p> <p>B) This button can only be used during Pause mode and when the heart symbol is displayed (you must use the heart rate grips to activate this mode).</p> <p>C) The console will monitor your pulse for 60 seconds and calculate a HEART RATE RECOVERY value from F1 to F6. F1 is best; F6 is worst (For Reference Only).</p> <p>D) The mode should be used for informational purposes only and not to diagnose or treat any medical conditions.</p> <p>E) Your pulse will be displayed for a few seconds after the heart symbol  is displayed.</p> <p>F) Press RECOVERY button again to return to main menu after testing.</p> <p>NOTE: You must hold the HEART RATE SENSOR grips on the handrails with both hands or wear the supplied wireless heart rate strap otherwise the console's HEART RATE value will display "P" and the main screen will display an "F6" reading once the timer reaches zero. This mode requires a constant heart rate feed to complete the calculations.</p>
 <p style="text-align: center;">TOTAL RESET</p>	<p>Press the TOTAL RESET button to restart the console.</p>
 <p style="text-align: center;">MODE</p>	<p>Rotate the multi-functional MODE button to select training programs, adjust resistance levels and navigate through program menus. Press the center of the MODE button to confirm / enter.</p>



CONSOLE INSTRUCTIONS – CONSOLE FUNCTIONS

 <p>SPEED RPM</p>	<p>SPEED: Displays your current pedaling speed as Miles per hour.</p> <p>RPM: Displays your current pedaling speed as revolutions per minute.</p>
 <p>TIME</p>	<p>TIME:</p> <ul style="list-style-type: none"> • Count Up: If a target time was not selected, TIME will count up from 0:00 to maximum 99:59 minutes. • Count Down: If you have pre-set the target time (1:00 TO 99:00; 1 MINUTE INCREMENT), the console will count down from that selected target time down to 0:00.
 <p>DISTANCE</p>	<p>DISTANCE:</p> <ul style="list-style-type: none"> • Count Up: If a target distance was not selected, this would measure the total distance from 0.00 to 99.9 miles. • Count Down: If you have set the target distance (1.0 TO 99.0; 1 MILE INCREMENT), the console will count down from that selected target distance down to 0.
 <p>CALORIES</p>	<p>CALORIES:</p> <ul style="list-style-type: none"> • Displays total calories burned during the current exercise session. • Count Up: If a target calorie was not selected, this would measure the total calories from 0 to 999 cal. • Count Down: If you have set the target calorie (10 TO 999; 10 CAL INCREMENT), the console will count down from that selected target calorie to 0.
 <p>WATT LEVEL</p>	<p>WATT:</p> <ul style="list-style-type: none"> • Display the current power you produce at a given resistance level. • Display the current value of Watts during exercise. • Display range: 0 ~ 999. <p>LEVEL:</p> <ul style="list-style-type: none"> • Displays resistance level of the current program, from 1 to 32 resistance levels; 1 level increment.
 <p>PULSE ♥</p>	<p>PULSE:</p> <ul style="list-style-type: none"> • Warning Reminder: If you have set the target pulse (30 TO 230 BPM (Beats Per Minute; 1 BPM INCREMENT)) the console buzzer will beep when actual heart rate is over the target value during workout. • You must place both of your hands on the Pulse Sensors on the Handlebar, or wear the supplied wireless heart rate strap. Your pulse will be displayed a few seconds after the heart symbol ♥ is displayed • If this machine does not detect a heart rate signal, the upper display console will turn off the pulse circuit and display an error message “P”. • Place your hands back on the Pulse Sensors correctly or wear the supplied wireless heart rate strap, the pulse readout will appear again.

CONSOLE INSTRUCTIONS – MANUAL PROGRAM (P1)

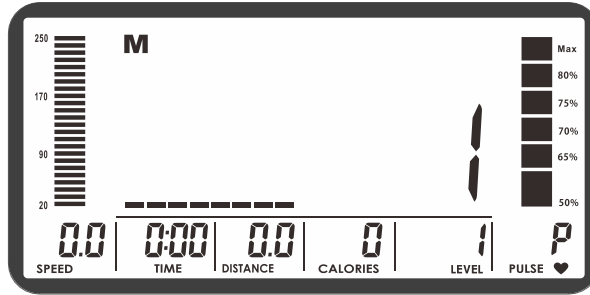

1 Login setting:

- A) Press **TOTAL RESET** button to turn on and/or reset the console.
- B) Choose **U1**, or **U2**, or **U3**, or **U4**
- C) Then fill out your personal information and press **MODE** button to confirm – **GENDER, AGE, HEIGHT, WEIGHT**.

2 MANUAL PROGRAM (P1)

A) MANUAL PROGRAM / QUICK START (P1)

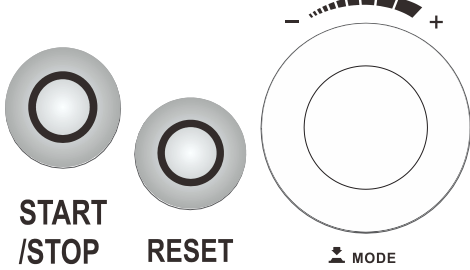
Option A	Option B
 <p>START /STOP</p>	 <p>START /STOP RESET MODE</p>
<p>When the power is turned on, the Manual Program (P1) will be selected, press START/STOP to begin your exercise.</p>	<p>A) Press START/STOP to pause the current program. B) Press RESET to return to main menu. C) Then rotate MODE to select Manual Program and press MODE to enter the program.</p>

B. SET THE LEVEL

 <p>LEVEL</p>	<p>Rotate the MODE dial to select the resistance level (from 1 to 32 levels) and press the center of the MODE dial to confirm.</p>
---	---

C. SET THE TIME

 <p>TIME</p>	<p>Rotate the MODE dial to set the desired TIME (1:00 TO 99:00) and press MODE to confirm.</p> <p>NOTE for TIME:</p> <ul style="list-style-type: none"> • Count Up: If a target time was not selected, TIME will count up from 0:00 to maximum 99:59 minutes. • Count Down: If you have set the target time (1:00 TO 99:00; 1 MINUTE INCREMENT), the console will count down from that selected target time down to 0:00.
--	---

CONSOLE INSTRUCTIONS – MANUAL PROGRAM (P1)

D. SET THE DISTANCE



DISTANCE

Rotate **MODE** to set the desired **DISTANCE (1.0 TO 99.0 MILE)** and press the center of the **MODE dial** to confirm.

NOTE for DISTANCE:

- Count Up: If a target distance was not selected, this would measure the total distance from 0.00 to 99.9 miles.
- Count Down: If you have set the target distance (**1.0 TO 99.0; 1 MILE INCREMENT**), the console will count down to 0 from that selected target distance.

E. SET THE CALORIES



CALORIES

Rotate **MODE** to set the desired **CALORIE (10 TO 999 CAL)** and press **MODE** to confirm.

NOTE for CALORIES:

- Count Up: If a target calorie was not selected, this would measure the total calories from 0 to 999 calories.
- Count Down: If you have set the target calories (**10 TO 999; 10 CAL INCREMENT**), the console will count down to zero from that selected target calorie goal.

F. SET THE PULSE



PULSE

Rotate **MODE** to set the desired **PULSE (30 TO 230 BPM)** and press **MODE** to confirm.

NOTE for PULSE:

- **Warning Reminder:** If you have set the target pulse (**30 TO 230 Beats Per Minute; 1 BPM INCREMENT**) the console alarm will sound when your actual heart rate exceeds the target value during workout.

G. START EXERCISE

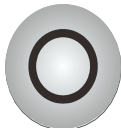

START
/STOP

A) Press **START/STOP** to begin your exercise.













B) During a workout, you can rotate **MODE** to select the resistance level (from 1 to 32 levels).

C) During workout, press **MODE** to see each current workout value (**SPEED, RPM, TIME, DISTANCE, CALORIES, WATT, PULSE**).

NOTE for HEART RATE: (Use included Wireless HR strap or Handheld HR grips)

- You must place both of your hands on the **Pulse Sensors** located on the **Handlebar** or wear the **supplied wireless heart rate strap**.
- Your pulse rate will appear approximately a few seconds after the heart symbol  is displayed. If this machine does not detect a heart rate signal, the upper display console will turn off the pulse circuit and display an error message "P."
- Place your hands back on the **Pulse Sensors** correctly or use the included wireless heart rate strap, the pulse readout will appear again.

CONSOLE INSTRUCTIONS – PROGRAM (P2 ~ P13)

 P2 GLUTE BLAST	 P3 PHYSICAL	 P4 RAMP	 P5 PLATEAU CLIMB
 P6 MOUNTAIN CLIMB 1	 P7 FITNESS TEST	 P8 IRON MAN	 P9 MOUNTAIN CLIMB 2
 P10 FAT BURN	 P11 HILL CLIMB	 P12 VALLEY	 P13 INTERVAL

1

Login setting:

- A) Press **TOTAL RESET** button to turn on and/or reset the console.
- B) Choose **U1**, or **U2**, or **U3**, or **U4**
- C) Fill out your personal stats and press **MODE** button to confirm – **GENDER, AGE, HEIGHT, WEIGHT.**

2

PROGRAM (P2~P13)

A. ENTER PROGRAM (P2 ~ P13)

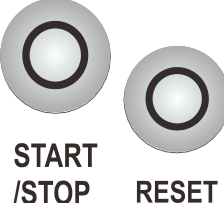
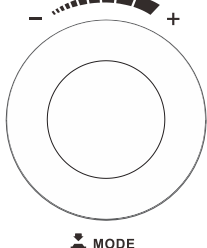
 START /STOP RESET	 MODE	<ol style="list-style-type: none"> A) Press START/STOP to pause the current program. B) Press RESET to return to main menu. C) Rotate MODE to select Program (P2 ~ P13) and press MODE to enter the program.
---	---	--



B. SET THE LEVEL

 LEVEL	Rotate MODE to select the workout profile level (from 1 to 16 profile levels) and press MODE to confirm.
---	---

C. SET THE TIME

 TIME	Rotate MODE to set the desired TIME (1:00 TO 99:00) . NOTE for TIME: <ul style="list-style-type: none"> • Count Up: If a target time was not selected, TIME will count up from 0:00 to maximum 99:59 minutes. • Count Down: If you have set the target time (1:00 TO 99:00; 1 MINUTE INCREMENT), the console will count down from that selected target time to 0:00.
--	--

D. START EXERCISE

 START /STOP	<ol style="list-style-type: none"> A) Press START/STOP to begin your exercise. B) During workout, you can rotate MODE to select the workout profile level (from 1 to 16 profile levels). C) Press MODE to see each current workout value (SPEED, RPM, TIME, DISTANCE, CALORIES, WATT, PULSE). <p>NOTE for HEART RATE: You must place both of your hands on the Pulse Sensors located on the Handlebar or wear the supplied wireless heart rate strap. Your pulse will be displayed approximately a few seconds after the heart symbol  is displayed.</p> <p>If this machine does not detect a heart rate signal, the upper display console will turn off the pulse circuit and display an error message "P."</p>
---	--

CONSOLE INSTRUCTIONS – H. R. C. PROGRAM (P14)

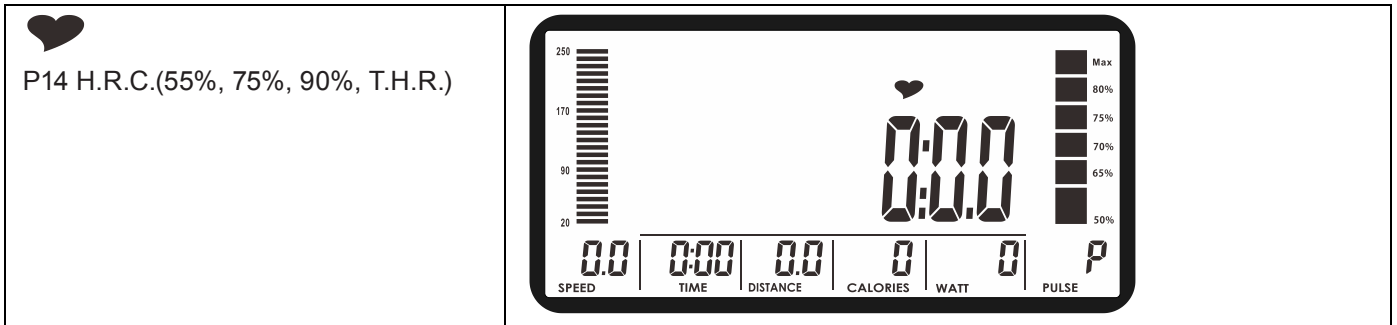

P14 H.R.C.(55%, 75%, 90%, T.H.R.)

1 Login setting:

- Press TOTAL RESET button to turn on/and or reset the console.
- Choose **U1**, or **U2**, or **U3**, or **U4**
Fill out your personal stats and press **MODE** button to confirm – **GENDER, AGE, HEIGHT, WEIGHT.**

2 H.R.C. PROGRAM (P14)

A. ENTER PROGRAM (P14)

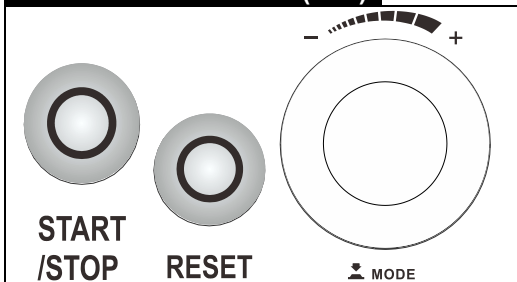

- Press **START/STOP** to pause the current program.
- Press **RESET** to return to main menu.
- Then rotate **MODE** to select **Heart Rate Program (P14)** and press **MODE** to enter the program.

B. SET THE TARGET HEART RATE

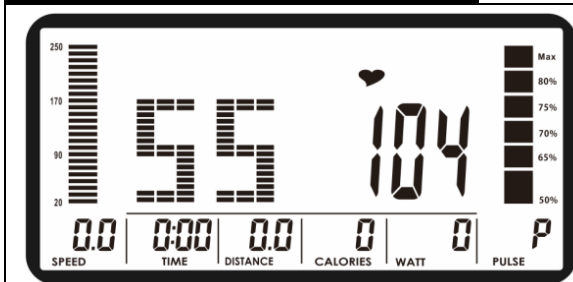

Rotate **MODE** to select the target heart rate (**55%, 75%, 90%, TARGET H.R.C.**) and press **MODE** to confirm.

NOTE for TARGET H.R.C.:

- TARGET H.R.C.** can be set up from **30 ~ 230 BPM (BEATS PER MINUTE) ; 1 BPM INCREMENT**

C. SET THE TIME



Rotate **MODE** to set the desired **TIME (1:00 TO 99:00).**

NOTE for TIME:

- Count Up:** If a target time was not selected, **TIME** will count up from 0:00 to maximum 99:59 minutes.
- Count Down:** If you have set the target time (**1:00 TO 99:00; 1 MINUTE INCREMENT**), the console will count down from that selected target time down to 0:00.

CONSOLE INSTRUCTIONS – H. R. C. PROGRAM (P14)

D. START EXERCISE



**START
/STOP**

A) Press **START/STOP** to begin your exercise.

B) Press **MODE** to see each current workout value (**SPEED, RPM, TIME, DISTANCE, CALORIES, WATT, PULSE**).

NOTE for HEART RATE:

- You must place both of your hands on the **Pulse Sensors** located on the **Handlebar** or **wear the supplied wireless heart rate strap**. Pulse will be displayed approximately a few seconds after the heart symbol  is displayed.
- If this machine does not detect a heart rate signal, then the console will turn off the pulse circuit and stop the program. The console will display an error message "**P**". Once you place your hands back on the **Pulse Sensors** or **wear the supplied wireless heart rate strap**, the pulse readout will appear again.

E. HEART RATE PROGRAM INFO.

- The console will monitor your actual pulse and adjust the resistance level automatically to keep your pulse within your **TARGET HEART RATE ZONE**.
- If your current pulse > (the value of the **TARGET HEART RATE**), the console will automatically decrease one resistance level and the console will sound an alarm to warn you to slow down.
- If your current pulse < (the value of the **TARGET HEART RATE**), the console will increase one resistance level automatically after every minute until you reach your target heart rate.

CONSOLE INSTRUCTIONS – WATT PROGRAM (P15)

W

P15 WATT CONTROL

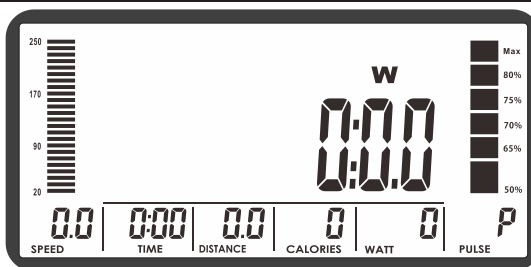

1

Login setting:

- Press **TOTAL RESET** button to turn on/and or reset the console.
- Choose **U1**, or **U2**, or **U3**, or **U4**
- Fill out your personal stats and press **MODE** button to confirm – **GENDER, AGE, HEIGHT, WEIGHT.**

2

WATT PROGRAM (P15)

A. WATT PROGRAM (P15)

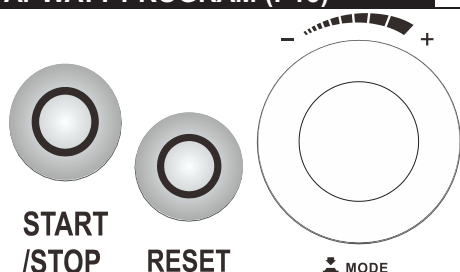

- Press **START/STOP** to pause the current program.
- Press **RESET** to return to main menu.
- Then rotate **MODE** to select **Watt Program (P15)** and press **MODE** to enter the program.

B. SET THE TARGET WATT

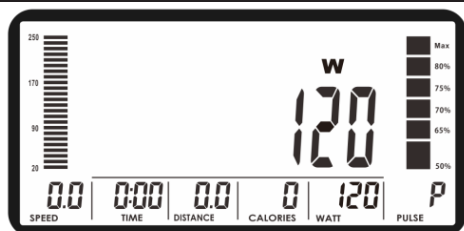

Rotate **MODE** to select the Watt value (**from 10 to 350 Watt**) and press **MODE** to confirm.

NOTE for WATT: (Current Speed + Resistance = WATTS)

- **WATT** can be set up from **10 ~ 350 WATT** ; **5 WATT INCREMENT**

C. SET THE TIME



Rotate **MODE** to set the desired **TIME (1:00 TO 99:00).**

NOTE for TIME:

- Count Up: If a target time was not selected, **TIME** will count up from 0:00 to maximum 99:59 minutes.
- Count Down: If you have set the target time (**1:00 TO 99:00; 1 MINUTE INCREMENT**), the console will count down from that selected target time down to 0:00.

D. START EXERCISE



START /STOP

- Press **START/STOP** to begin your exercise.
- During workout, you can rotate **MODE** to adjust the Watts value (**from 10 ~ 350**).
- Press **MODE** to see each current workout value (**SPEED, RPM, TIME, DISTANCE, CALORIES, WATT, PULSE**).

NOTE for HEART RATE: You must place both of your hands on the **Pulse Sensors** located on the **Handlebar** or wear the **supplied wireless heart rate strap**. Your pulse will be displayed approximately a few seconds after the heart symbol  is displayed. If this machine does not detect a heart rate signal, the upper display console will turn off the pulse circuit and display an error message "P."

CONSOLE INSTRUCTIONS – USER PROGRAM (P16)

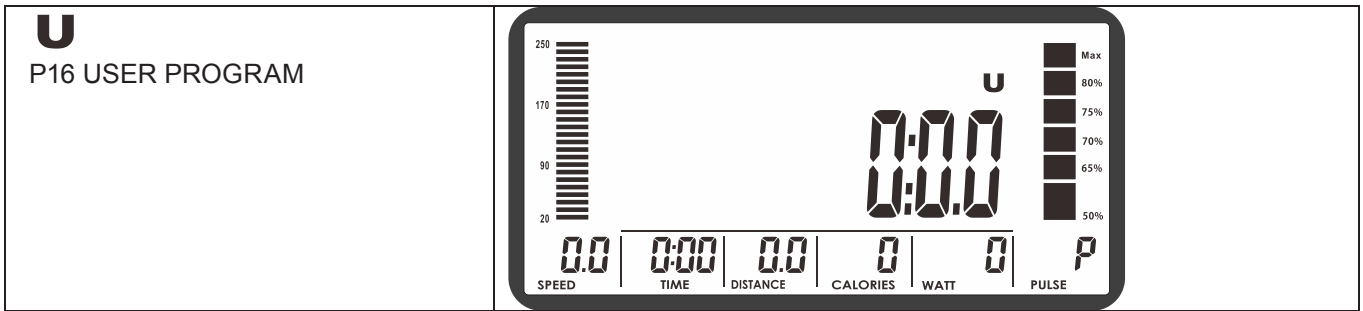

U P16 USER PROGRAM

1 Login setting:

- Press **TOTAL RESET** button to turn on/and or reset the console.
- Choose **U1**, or **U2**, or **U3**, or **U4**
- Fill out your personal stats and press **MODE** button to confirm – **GENDER, AGE, HEIGHT, WEIGHT.**

2 USER PROGRAM (P16)

A. ENTER USER PROGRAM (P16)

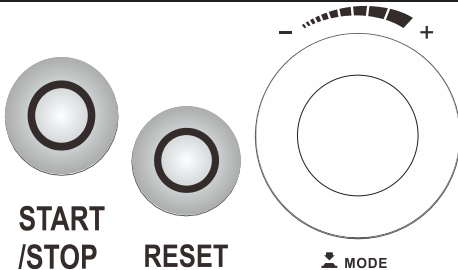

- Press **START/STOP** to pause the current program.
- Press **RESET** to return to main menu.
- Then rotate **MODE** to select **User Program (P16)** and press **MODE** to enter the program.

B. SET THE TORQUE/RESISTANCE LEVEL

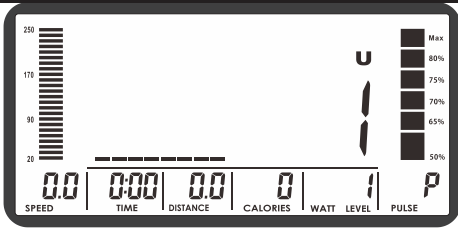

- The **USER SETTING PROGRAM** allows the user to create a custom course with up to 8 segments. The user can set their desired resistance level for each individual segment.
- Rotate **MODE** button to set **EACH TIME INTERVAL** and **RESISTANCE LEVEL (1 TO 32 RESISTANCE LEVELS)**, then press **MODE** button to confirm.
- Continue with the above steps and finish setting up the desired **RESISTANCE LEVEL** for each of the 8 individual intervals. The program profile will be stored in the memory after setup.
- You can modify the profile anytime.

C. START EXERCISE



START /STOP

- Press **START/STOP** to begin your exercise.
- During workout, you can rotate **MODE** to adjust the tension level (from 1 to 32 levels).
- Press **MODE** to see each current workout value (**SPEED, RPM, TIME, DISTANCE, CALORIES, WATT, PULSE**).

NOTE for HEART RATE: You must place both of your hands on the **Pulse Sensors** located on the **Handlebar** or wear the **supplied wireless heart rate strap**. Your pulse will be displayed approximately a few seconds after the heart symbol ♥ is displayed. If this machine does not detect a heart rate signal, the upper display console will turn off the pulse circuit and display an error message "P."

CONSOLE - USB

Left side port is intentionally left blank.

USB Charging Port for mobile devices and tablets.

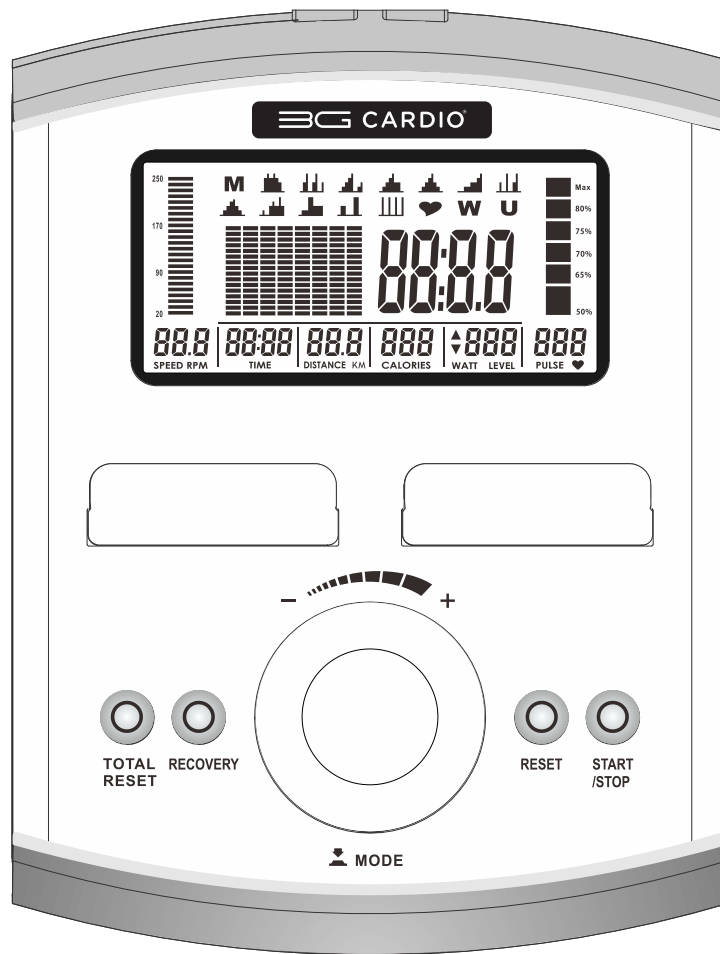

HEART RATE INFORMATION

TARGET HEART RATE ZONE – Before starting any exercise program consult your physician.

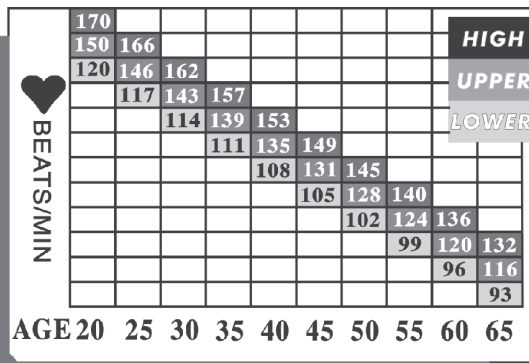

Target Heart Rate Zone
 $220 - \text{Your Age} = \text{Maximum Heart Zone}$

You do not want to workout at your maximum heart rate. The recommended Heart Rate Zone is a percentage of your maximum heart rate. Between 60% and 75% of your maximum heart rate.

Lower limit of Target Heart Rate Zone = Maximum heart rate X 0.6

Upper limit of Target Heart Rate Zone = Maximum heart rate X 0.75

HOW OFTEN SHOULD YOU EXERCISE?

You should exercise three to four times a week, 30 minutes per workout, or as instructed by your doctor.

HOW HARD SHOULD YOU EXERCISE?

Intensity of exercise is reflected in your heart rate. Exercise must be sufficiently rigorous to strengthen your heart muscle and condition your cardiovascular system. Before starting any exercise program consult your physician.

HOW LONG SHOULD YOU EXERCISE?

Sustained exercise conditions your heart, lungs and muscles. The longer you are able to sustain exercise within your target heart range, the greater the aerobic benefits. You should always begin a workout with at least a 5 minute warm up at low intensity.

If you have any known heart / cardiovascular issues you must consult with your doctor to find out if you are healthy enough for exercise.

Beginner Program

	Exertion Level	Duration
Week 1	Easy	6 – 12 Minutes
Week 2	Easy	10 – 16 Minutes
Week 3	Moderate	14 – 20 Minutes
Week 4	Moderate	18 – 24 Minutes
Week 5	Moderate	22 – 28 Minutes
Week 6	Slightly higher or slightly lower	30 Minutes
Week 7	Add interval training	3 minutes at moderate, then 3 minutes at higher exertion, then 3 minutes at easy. Continue this pattern for 24–30 minutes.

IMPORTANT MESSAGE ABOUT Bluetooth® – PLEASE READ!

We have created videos to help you get started. You can check these videos out here:

www.3gcardio.com/connect

What you need to know about Bluetooth®:

NOTICE: This console is equipped with an FTMS Bluetooth® interface. Please take note that your mobile device or tablet needs to be compatible with the Bluetooth® interface (Bluetooth® 4.0 or above). To use training apps, you will have to activate (turn on) the Bluetooth® function on your mobile device (tablet or smart phone) and start the fitness app.

Important! Once you turn on the Bluetooth® feature on your device, open the fitness app of your choice and follow the instructions. The app should explain to you the order of events for connecting to the Elite EM X Elliptical Trainer. Please follow the instructions given in the app.

You will find the specific Bluetooth® name of your Elite EM X Elliptical Trainer on a small sticker on the back of the console.

You can search for fitness apps in the Google Play Store or Apple iOS App Store.



Kinomap™, Zwift™ and iCardio™ are examples of some fitness apps you can try out. Please note that these apps are produced by 3rd party designers. 3G Cardio cannot endorse or approve any 3rd party design software or their success, accuracy, privacy or safety. We also do not track changes in 3rd party software so what may work today with our machines, may not work tomorrow.

Please understand that every device and every app is different. Some apps may work perfectly, some apps may not work at all. Once powered on, your 3G Cardio Elite EM X Elliptical Trainer will send out a Bluetooth® signal and your mobile device or tablet will find it. What happens after that depends on your device and the app you choose.

Maintenance of your 3G Cardio Elliptical

WARNING: Always unplug your 3G Cardio Elliptical prior to cleaning and servicing to avoid electrical hazard or shock.

Always wipe down your elliptical after a workout. Sweat and perspiration is very corrosive to metal and electronics and a good cleaning after a workout will keep your elliptical from potential long term damage. Never use unapproved chemicals and solvents to clean your elliptical.

A protective coating has been applied to the electronics display and only cleaning solutions meant for electronics should be used. This type of cleaner can easily be found online or at your local hardware store and is the same type of cleaner used on flat screen TVs and computers. If you ever have questions about the cleaning and care of your 3G Cardio product, call us at 888-888-7985 or by email at Support@3GCardio.com.

Before each use, it is very important to check the elliptical for loose bolts, knobs, levers or screws and if found, resolve before performing any exercise. If you hear, feel or notice any type of sound, scraping, clunking or grinding, contact an authorized 3G Cardio service technician or call us directly at 888-888-7985. We will help to resolve the problem.

It will be important to do this asap as a small problem can turn into a bigger problem if left unresolved. It is also important to resolve any issues to prevent a potential safety issue.

If you have any questions about assembly, service or about the elliptical in general, please call us at 888-888-7985.

PRODUCT PARTS DRAWING (A)

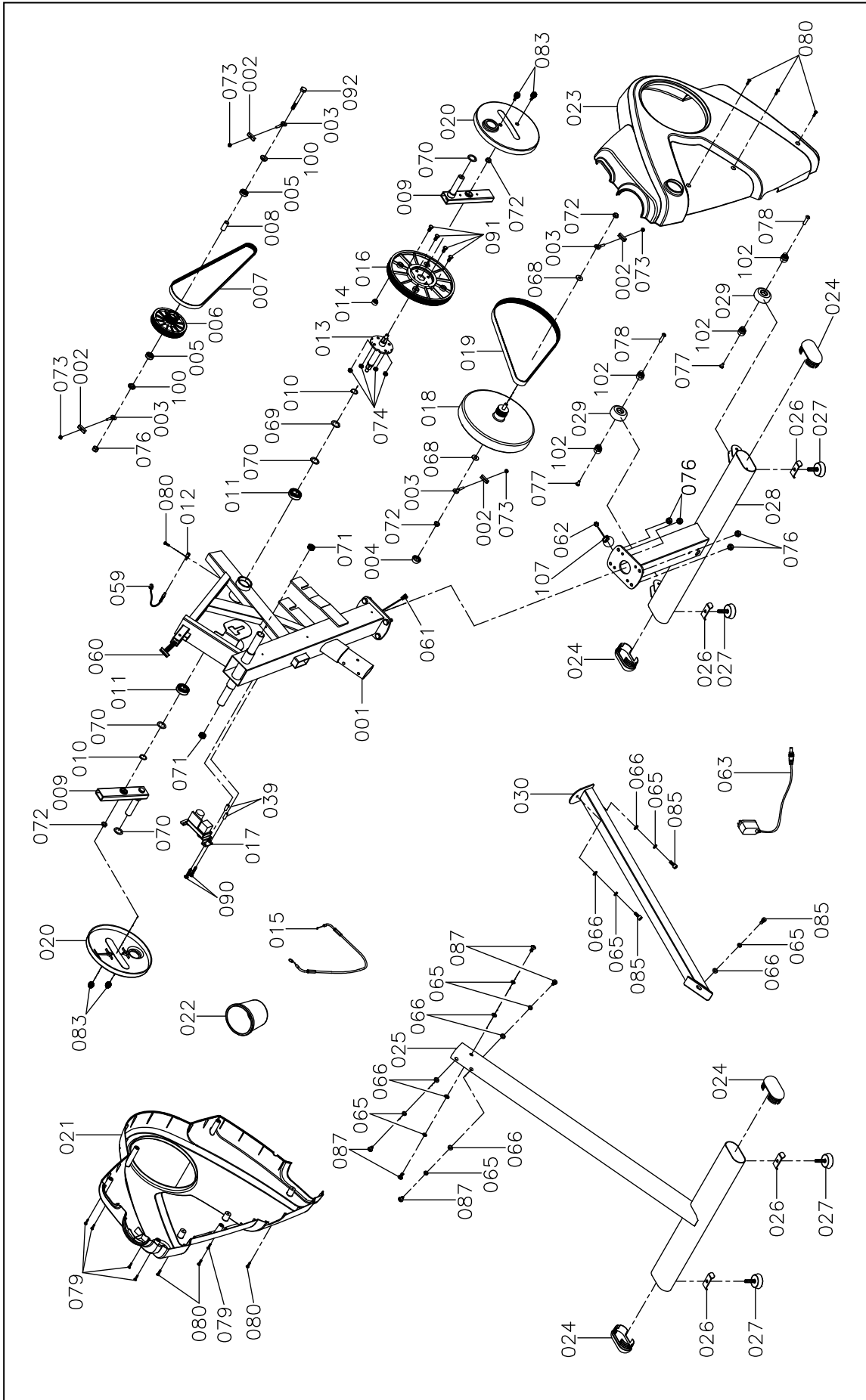

PRODUCT PARTS DRAWING (B)

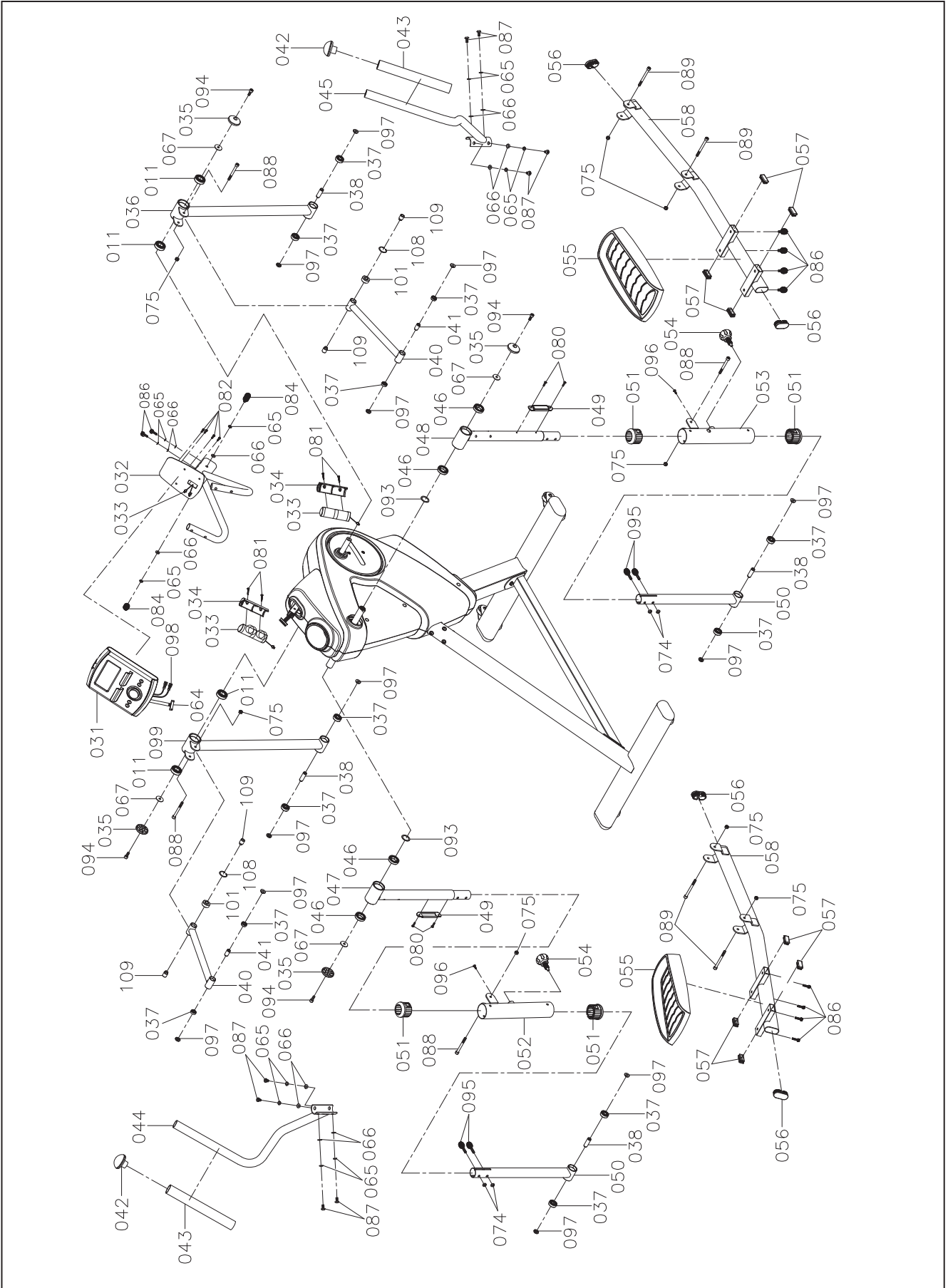

PART LIST

NO.	Item Name	Q'TY
1	Main Frame	1
2	Tension Bracket	4
3	Eye Bolt	4
4	Screw Cap	1
5	Bearing (6000)	2
6	Pulley (120-42mm)	1
7	Belt (1092J6)	1
8	Spacer (10x14x32mm)	1
9	Crank	2
10	C-Ring	2
11	Bearing (6004)	6
12	Sensor Stand	1
13	Crank Axle	1
14	Magnet	1
15	Cable	1
16	Pulley (235mm)	1
17	Motor	1
18	Flywheel	1
19	Belt (1059J8)	1
20	Crank Cover	2
21	Left Cover	1
22	Accessory Tray	1
23	Right Cover	1
24	EndCap	4
25	Rear Stabilizer	1
26	Fixed Plate for Leveler	4
27	Leveler	4
28	Front Stabilizer	1
29	Transportation Wheel	2
30	Support Tube	1
31	Console	1
32	Fixed Handlebar	1
33	Pulse Sensor Top Housing w/ Wire	2
34	Pulse Sensor Bottom Housing	2
35	Tube Cap	4

NO.	Item Name	Q'TY
36	Right Swing Arm	1
37	Bearing (6201)	12
38	Spacer (8x14x40mm) for Telescoping Bar	4
39	Spacer (6x8x22mm)	2
40	Crank Linkage	2
41	Spacer (8x14x28mm) for Crank Linkage	2
42	Handheld Plug	2
43	Foam Grip for Upper Handlebar	2
44	Left Upper Handlebar	1
45	Right Upper Handlebar	1
46	Bearing (6905)	4
47	Left Pivoting Arm	1
48	Right Pivoting Arm	1
49	Stride Length Adjustment Plate	2
50	Telescoping Bar	2
51	Connection Plug (60x38)	4
52	Left Adjustment Tube	1
53	Right Adjustment Tube	1
54	Pull Pin	2
55	Pedal	2
56	Oval Plug (30x60)	4
57	Square Plug (20x40)	8
58	Pedal Support Arm	2
59	Sensor Wire	1
60	Upper Connection Wire	1
61	Middle Adaptor Connection Wire	1
62	Lower Adaptor Connection Wire	1
63	Adaptor (9V / 1.5A)	1
64	Connection Wire to Console	1
65	Lock Washer (M8)	20
66	Washer (8x16x2.0t)	20
67	Washer (8x30x3.0t)	4
68	Washer (10x23x2.0t)	2
69	Washer (21x30x0.5t)	1
70	Washer (21x30x1.0t)	4

PART LIST

NO.	Item Name	Q'TY
71	Tube Connector Nut	2
72	Flange Nut (M10xp1.25)	4
73	Nylon Nut (M6xp1.0)	4
74	Thin Nylon Nut (M8xp1.25)	8
75	Nylon Nut (M8xp1.25)	8
76	Nylon Nut (M10xp1.5)	5
77	Bolt (M6xp1.0x12mm)	2
78	Bolt (L=30mm)	2
79	Screw (M4x20mm)	5
80	Screw (M5x20mm)	11
81	Screw (M3xp0.5x16mm)	4
82	Screw (M5xp0.8x15mm)	4
83	Bolt (M6xp1.0x12mm)	4
84	Bolt (M8xp1.25x16mm)	2
85	Bolt (M8xp1.25x20mm)	3
86	Bolt (M8xp1.25x30mm)	10
87	Bolt (M8xp1.25x16mm)	13
88	Bolt (M8xp1.25x65mm)	4
89	Bolt (M8xp1.25x80mm)	4
90	Bolt (M5x32mm)	2
91	Bolt (M8xp1.25x15mm)	4
92	Bolt (M10xp1.5x85mm)	1
93	Washer (26x34x1.0t)	2
94	Bolt (M8xp1.25x25mm)	4
95	Bolt (M8xp1.25x45mm)	4
96	Screw (M5xp0.8x15mm)	2
97	Axle Cap	12
98	Pulse Connection Wire to Console	1
99	Left Swing Arm	1
100	Pedal Wheel Bearing Adapter	2
102	Bearing (608Z)	4
107	Snap Bushing	1
108	C-Ring	2
109	Wheel Bearing Spacer (8x16x22mm)	4

3G CARDIO WARRANTY

What does this warranty cover? This warranty covers your 3G Cardio Elite EM X Elliptical Trainer against defects in material and workmanship when used for the purpose intended, under normal conditions, and provided it receives proper care and maintenance.

How long does the coverage last? Warranty starts from the date of purchase and is as follows:

Residential Warranty: Lifetime frame, 5 years parts, 1 year in-home labor.

Model	Labor	Parts	Max User Weight	Daily Usage	Voltage
Elite EM X	1 Year	5 Years	350lbs	Up to 4 hours	9V / 1.5A Adaptor

***Light Commercial Warranty: 1 year frame, 1 year parts, 1 year on-site labor.**

Model	Labor	Parts	Max User Weight	Daily Usage	Voltage Required
Elite EM X	1 Year	1 Years	350lbs	Up to 4 hours	9V / 1.5A Adaptor

*A 3G Cardio product is placed into a location with a business address and therefore not a residential setting.

What will 3G Cardio do? 3G Cardio’s manufacturer warranty will provide a replacement part and/or service at no charge for any part found defective in workmanship or materials during the warranty period.

How do you get service? In order to obtain replacement parts or service as provided by this warranty, please call the location where you purchased the bike or call 3G Cardio (1-888-888-7985) Monday through Friday 9:00 a.m. to 5:00 p.m. Arizona time. Ask to speak to the service department and please have your serial number, date of purchase, original bill of sale and location of purchase available.

This warranty shall not apply to a 3G Cardio Elite EM X Elliptical Trainer which is subject to misuse, neglect, accident, or unauthorized repairs and alterations. This warranty is only valid to the original owner and is nontransferable if sold, traded, bartered or for any other reason of change of ownership. An original bill of sale must be made available stating the purchase date, owner’s name, model and place of sale in order to validate warranty. No exceptions will be made otherwise. All other obligations or liabilities, including liability for consequential damages, are hereby excluded. All of the parts for the 3G Cardio Elite EM X Elliptical Trainer can be ordered from 3G Cardio, 14647 So. 50th Street #110, Phoenix, Arizona 85044. Parts will be shipped and billed at the current prices, which are subject to change without notice.

Labor is covered under the manufacturer’s warranty period where there is a local 3G Cardio service provider available. For inquiries on service providers and their locations please call toll free 1-888-888-7985.

Register your product at www.3gcardio.com/register



3G Cardio Fitness Equipment
14647 So. 50th Street Suite 110
Phoenix, AZ 85044

1-888-888-7985
www.3GCardio.com